

PM4H/4S Timers

Timers/Time Switches/Counters/Hour Meters



**MULTI-RANGE
ANALOG TIMER** **PM4S
Timers**



RoHS Directive compatibility information
<http://www.nais-e.com/>

Features

1. Economic pricing that promptly reflects market demands

Remarkable economic pricing is implemented in pursuit of cost performance.

2. Output contacts switchable between timed out 2C and timed out 1C/Instantaneous 1C

The timed out 1C/Instantaneous 1C output contact enables the efficient addition of self-maintenance circuits.

3. 4 different time ranges selectable on a single unit

Five types of timers cover the full range of time settings from 1 second to 30 hours.

4. Equipped with zero-setting instantaneous output

Set the dial all the way to "0" for instantaneous operation, so circuit testing can be easily accomplished.

5. Compliant with UL, c-UL and CE.

Product types

Type	//////	Contact arrangement	Time range	Operating voltage	Part No.
PM4S Multi-range Timer A type	Power ON-delay	T.D.: Timed-out 2C INST.: Timed-out 1C Instantaneous 1C (Selected by front switch)	1s/10s/1min/10min (4 time ranges selectable)	100 to 120V AC	PM4S-A2C10M-AC120V
				200 to 240V AC	PM4S-A2C10M-AC240V
				12V DC	PM4S-A2C10M-DC12V
				24V DC	PM4S-A2C10M-DC24V
PM4S Multi-range Timer B type			3s/30s/3min/30min (4 time ranges selectable)	100 to 120V AC	PM4S-A2C30M-AC120V
				200 to 240V AC	PM4S-A2C30M-AC240V
				12V DC	PM4S-A2C30M-DC12V
				24V DC	PM4S-A2C30M-DC24V
PM4S Multi-range Timer C type			6s/60s/6min/60min (4 time ranges selectable)	100 to 120V AC	PM4S-A2C60M-AC120V
				200 to 240V AC	PM4S-A2C60M-AC240V
				12V DC	PM4S-A2C60M-DC12V
				24V DC	PM4S-A2C60M-DC24V
PM4S Multi-range Timer D type	1min/10min/1h/10h (4 time ranges selectable)	100 to 120V AC	PM4S-A2C10H-AC120V		
		200 to 240V AC	PM4S-A2C10H-AC240V		
		12V DC	PM4S-A2C10H-DC12V		
		24V DC	PM4S-A2C10H-DC24V		
PM4S Multi-range Timer E type	3min/30min/3h/30h (4 time ranges selectable)	100 to 120V AC	PM4S-A2C30H-AC120V		
		200 to 240V AC	PM4S-A2C30H-AC240V		
		12V DC	PM4S-A2C30H-DC12V		
		24V DC	PM4S-A2C30H-DC24V		

Parts name

• The PM4S Multi-Range timer allows time units and output contacts to be selected via front switches.

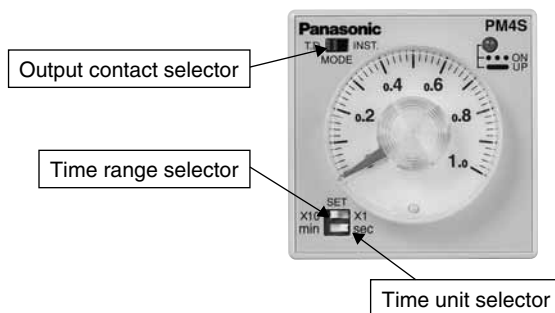

PM4S

Specifications

Item		Type	PM4S Multi-range Timer					
Rating	Rated operating voltage		100 to 120V AC		200 to 240V AC	12V DC	24V DC	
	Rated frequency		50/60 Hz				—	
	Rated power consumption		Approx. 3.0VA/3.6VA (at 100V AC) Approx. 4.5VA/5.25VA (at 120V AC)	Approx. 5.6VA/6.8VA (at 200V AC) Approx. 7.5VA/9.8VA (at 240V AC)	Approx. 1.3W		Approx. 1.7W	
	Output rating		5A 250V AC (resistive load)					
	Operating mode		Power ON-delay					
	Time range	A type		1s/10s/1min/10min (4 time ranges selectable)				
		B type		3s/30s/3min/30min (4 time ranges selectable)				
C type			6s/60s/6min/60min (4 time ranges selectable)					
D type			1min/10min/1h/10h (4 time ranges selectable)					
E type			3min/30min/3h/30h (4 time ranges selectable)					
Time accuracy Note)	Operating time fluctuation		±1% (power off time change at the range of 0.1s to 1h)					
	Setting error		±5% (Full-scale value)					
	Voltage error		±1% (at the operating voltage changes between 85 to 110%)					
	Temperature error		±2% (at 20°C ambient temp. at the range of -10 to +50°C +14 to +122°F)					
Contact	Contact arrangement		T.D.: Timed-out 2 Form C INST.: Timed-out 1 Form C, instantaneous 1 Form C (Selected by front switch)					
	Contact resistance (Initial value)		Max. 100mΩ (at 1A 6V DC)					
	Contact material		Silver alloy					
Life	Mechanical (contact)		Min. 10 ⁷					
	Electrical (contact)		Min. 10 ⁵ (at rated control capacity)					
Electrical function	Allowable operating voltage range		85 to 110% of rated operating voltage					
	Insulation resistance (Initial value)		Min. 100MΩ	Between live and dead metal parts Between input and output Between contacts of different poles Between contacts of same pole			(At 500V DC)	
	Breakdown voltage (Initial value)		2,000Vrms for 1 min Between live and dead metal parts 2,000Vrms for 1 min Between input and output 2,000Vrms for 1 min Between contacts of different poles 1,000Vrms for 1 min Between contacts of same pole					
	Min. power off time		100 ms					
	Max. temperature rise		55°C 131°F					
Mechanical function	Vibration resistance	Functional	10 to 55Hz: 1 cycle/min double amplitude of 0.25mm (10min on 3 axes)					
		Destructive	10 to 55Hz: 1 cycle/min double amplitude of 0.375mm (1h on 3 axes)					
	Shock resistance	Functional	Min. 98m/s ² (4 times on 3 axes)					
		Destructive	Min. 980m/s ² (5 times on 3 axes)					
Operating condition	Ambient temperature		-10 to +50°C +14 to +122°F					
	Ambient humidity		30 to 85%RH (non-condensing)					
	Atmospheric pressure		860 to 1,060hPa					
	Ripple factor (DC type)		20%					
Others	Weight		Approximately 110 g 3.880 oz					

Notes) 1. Unless otherwise specified, the measurement conditions at the maximum scale time standard are specified to be the rated operating voltage (within 5% ripple factor for DC), 20°C 68°F ambient temperature, and 1s power off time.
2. For the 1s range, the tolerance for each specification becomes ±10ms.

Applicable standard

Safety standard	EN61812-1	Pollution Degree 2/Overvoltage Category III
EMC	(EMI)EN61000-6-4 Radiation interference electric field strength Noise terminal voltage (EMS)EN61000-6-2 Static discharge immunity	EN55011 Group1 ClassA EN55011 Group1 ClassA
	RF electromagnetic field immunity	EN61000-4-2 4 kV contact 8 kV air
	EFT/B immunity	EN61000-4-3 10 V/m AM modulation (80 MHz to 1 GHz) 10 V/m pulse modulation (895 MHz to 905 MHz)
	Surge immunity	EN61000-4-4 2 kV (power supply line)
	Conductivity noise immunity	EN61000-4-5 1 kV (power line)
	Power frequency magnetic field immunity	EN61000-4-6 10 V/m AM modulation (0.15 MHz to 80 MHz)
	Voltage dip/Instantaneous stop/Voltage fluctuation immunity	EN61000-4-8 30 A/m (50 Hz) EN61000-4-11 10 ms, 30% (rated voltage) 100 ms, 60% (rated voltage) 1,000 ms, 60% (rated voltage) 5,000 ms, 95% (rated voltage)

Dimension (Unit: mm inch) Tolerance: $\pm 0.5 \pm .020$

• **Surface mount dimensions**

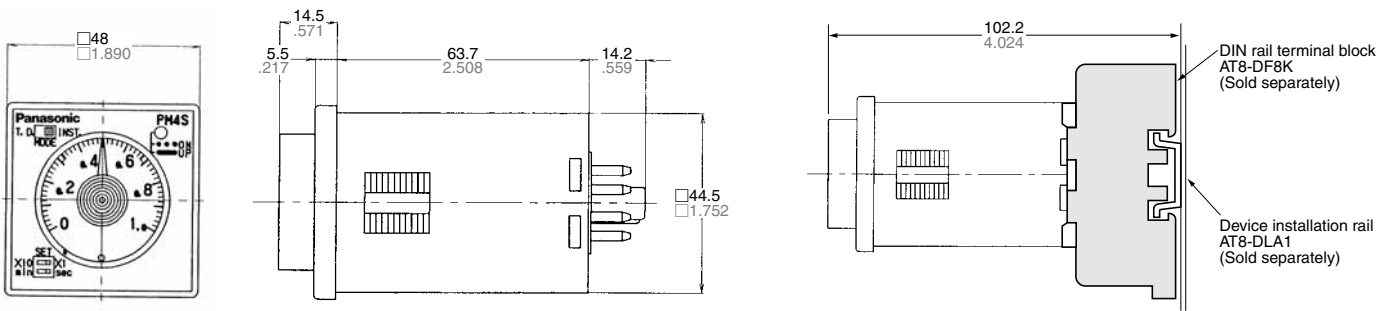

• **Panel mount dimensions (with mounting frame)**

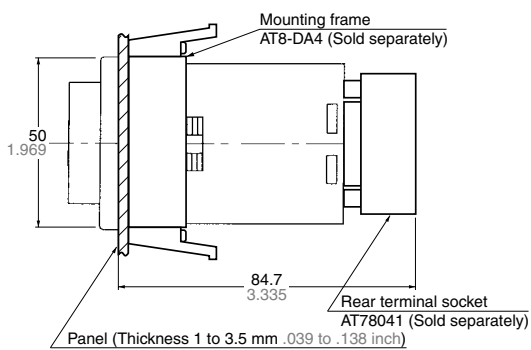

• **Panel cut out dimensions**

Standard cut out dimensions are shown below.
Use mounting frame (AT8-DA4) and rubber gasket (ATC18002).

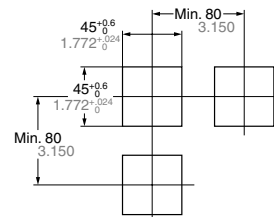

• **Adjacent mounting**

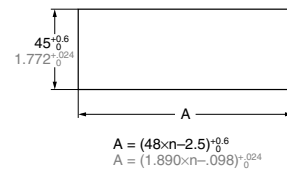

• **Terminal layouts and wiring diagrams**

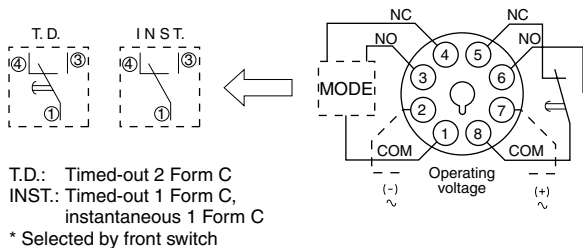

Notes:

- Operating voltage signs in parentheses () indicate the polarity of the DC type.
- is a time delay contact.
- is an instantaneous contact.

Operation mode

1. **T.D. mode**

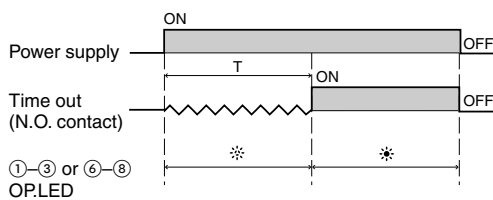

2. **INST. mode**

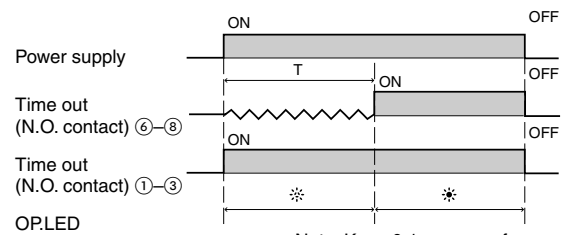

Note: Keep 0.1s or more for power off time.

Precautions during usage

1. Avoid locations subject to flammable or corrosive gases, excessive dust, oil, vibrations, or excessive shocks.
2. Since the main-unit is made of polycarbonate resin, avoid contact with or use in environments containing methyl alcohol, benzene, thinners, and other organic solvents; and ammonia, caustic sodas, and other alkaline substances.
3. **Power supply superimposed surge protector**

Although a surge protector will withstand standard-waveform voltage with the values in the next table, anything above this will destroy the internal circuit. You should therefore use a surge absorber.

12 V DC 24 V DC	100 to 120 V AC 200 to 240 V AC
500 V	4,000 V

- Surge waveform
[$\pm(1.2 \times 50) \mu\text{s}$ uni-polar full wave voltage]

4. In order to maintain the characteristics, do not remove the timer case.
5. When installing the panel, use the ATA4811 mounting frame (Sold separately).
6. If you change the operating voltage, be sure not to allow leak current into the timer.
7. Avoid leaving the unit powered continuously. Leaving the unit powered up with output set to ON continuously for a long period of time (about 1 month or more) will wear out the electronic components. If you will be keeping it powered continuously, combine with a relay to create the circuit shown below:

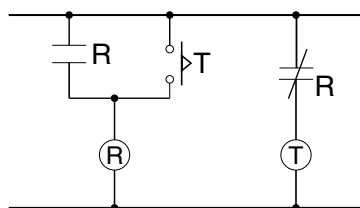

8. The timer setting dial should only be turned within the range indicated on the dial face. Turning it too far may break the stopper and cause damage to internal components.

Acquisition of CE marking

Please abide by the conditions below when using in applications that comply with EN61812-1.

1. Overvoltage category III, pollution level 2
2. The load connected to the output contact should have basic insulation. This timer is protected with basic insulation and can be double-insulated to meet EN/IEC requirements by using basic insulation on the load.

3. Please use a power supply that is protected by an overcurrent protection device which complies with the EN/IEC standard (example: 250 V 1 A fuse, etc.).
4. You must use a terminal socket or socket for the installation. Do not touch the terminals or other parts of the timer when it is powered. When installing or un-installing, make sure that no voltage is being applied to any of the terminals.

5. Do not use this timer as a safety circuit. For example when using a timer in a heater circuit, etc., provide a protection circuit on the machine side.

**DIN48 SIZE
MULTI-RANGE
ANALOG TIMER**

**PM4H-A
PM4H-S
PM4H-M**

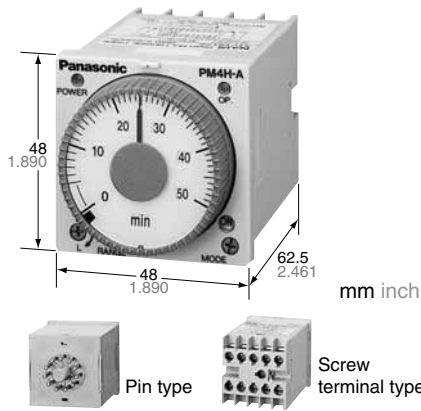

UL File No.: E122222
CSA File No.: LR39291



Features

- 100-240V AC free-voltage input, 48-125V DC type available
- Short body — 62.5mm 2.461 inch (screw terminal type)
- Front panel of IP65 type is protected against water-splash and dust
- Built-in Screw terminals
Screw terminal type is used for easy wiring and reducing additional cost for accessories.
- 0 setting instantaneous output operation
- Multiple time ranges — 1 s to 500 h (Max.)
- 8 different operation modes: (PM4H-A)
- Compliant with UL/CSA, CE and LLOYD

RoHS Directive compatibility information
<http://www.nais-e.com/>

Product types

Type	Operation mode	Contact arrangement	Time range	Protective construction	Rated operating voltage	Terminal type	Part number
PM4H-A	8 operation modes • Pulse ON-delay • Pulse Flicker • Pulse ON-flicker • Differential ON/OFF-delay (1) (2) • Signal OFF-delay • Pulse One-shot • Pulse One-cycle	Relay Timed-out 2 Form C		IP65	100 to 240V AC	11 pins	PM4HA-H-AC240VW
						Screw terminal	PM4HA-H-AC240VSW
					48 to 125V DC	11 pins	PM4HA-H-DC125VW
						Screw terminal	PM4HA-H-DC125VSW
					24V AC/DC	11 pins	PM4HA-H-24VW
						Screw terminal	PM4HA-H-24VSW
					12V DC	11 pins	PM4HA-H-DC12VW
						Screw terminal	PM4HA-H-DC12VSW
				IP50	100 to 240V AC	11 pins	PM4HA-H-AC240V
						Screw terminal	PM4HA-H-AC240VS
					48 to 125V DC	11 pins	PM4HA-H-DC125VS
						Screw terminal	PM4HA-H-DC125VS
PM4H-S	Power ON-delay	Relay Timed-out 2 Form C	16 selectable ranges 1s to 500h	IP65	100 to 240V AC	8 pins	PM4HS-H-AC240VW
						Screw terminal	PM4HS-H-AC240VSW
					48 to 125V DC	8 pins	PM4HS-H-DC125VW
						Screw terminal	PM4HS-H-DC125VSW
					24V AC/DC	8 pins	PM4HS-H-24VW
						Screw terminal	PM4HS-H-24VSW
					12V DC	8 pins	PM4HS-H-DC12VW
						Screw terminal	PM4HS-H-DC12VSW
				IP50	100 to 240V AC	8 pins	PM4HS-H-AC240V
						Screw terminal	PM4HS-H-AC240VS
					48 to 125V DC	8 pins	PM4HS-H-DC125V
						Screw terminal	PM4HS-H-DC125VS
PM4H-M	5 operation modes (With instantaneous contact) • Power ON-delay • Power Flicker • Power ON-flicker • Power One-shot • Power One-cycle	Relay Timed-out 1 Form C Instantaneous 1 Form C		IP65	100 to 240V AC	8 pins	PM4HM-H-AC240VW
						Screw terminal	PM4HM-H-AC240VSW
					48 to 125V DC	8 pins	PM4HM-H-DC125VW
						Screw terminal	PM4HM-H-DC125VSW
					24V AC/DC	8 pins	PM4HM-H-24VW
						Screw terminal	PM4HM-H-24VSW
					12V DC	8 pins	PM4HM-H-DC12VW
						Screw terminal	PM4HM-H-DC12VSW
				IP50	100 to 240V AC	8 pins	PM4HM-H-AC240V
						Screw terminal	PM4HM-H-AC240VS
					48 to 125V DC	8 pins	PM4HM-H-DC125V
						Screw terminal	PM4HM-H-DC125VS
	24V AC/DC	8 pins	PM4HM-H-24V				
		Screw terminal	PM4HM-H-24VS				
	12V DC	8 pins	PM4HM-H-DC12V				
		Screw terminal	PM4HM-H-DC12VS				

If you use this timer under harsh environment, please order above sealed type (IP65 type). IP65 type — Protection dust and water jet splay on the front face.

PM4H-A/S/M

Time range

Scale		Time unit			
		sec	min	hrs	10h
1	Control time range	0.1s to 1s	0.1 min to 1 min	0.1h to 1h	1.0h to 10h
5		0.5s to 5s	0.5 min to 5 min	0.5h to 5h	5h to 50h
10		1.0s to 10s	1.0 min to 10 min	1.0h to 10h	10h to 100h
50		5s to 50s	5 min to 50 min	5h to 50h	50h to 500h

PM4H-A/PM4H-S/PM4H-M
All types of PM4H timer have multi-time range.
16 time ranges are selectable.
1s to 500h (Max. range) is controlled.

Note: 0 setting is for instantaneous output operation.

Specifications

Item	Type	PM4H-A	PM4H-S	PM4H-M
Rating	Rated operating voltage	100 to 240V AC, 48 to 125V DC, 12V DC, 24V AC/DC		
	Rated frequency	50/60Hz common (AC operating type)		
	Rated power consumption	Approx. 10VA (100 to 240V AC) Approx. 2.5VA (24V AC) Approx. 1.5W (12V DC, 24V DC, 48 to 125V DC)		
	Rated control capacity	5A 250V AC (resistive load)		
	Operating mode	Pulse ON-delay Pulse Flicker Pulse ON-Flicker Differential ON/OFF-delay (1) (2) Signal OFF-delay Pulse One-shot Pulse One-cycle	Power ON-delay	Power ON-delay Power Flicker Power ON-flicker Power One-shot Power One-cycle (with instantaneous contact)
	Time range	1s to 500h (Max.) 16 time ranges switchable		
Time accuracy (Note:)	Operating time fluctuation	±0.3% (power off time change at the range of 0.1s to 1h)		
	Setting error	±5% (Full-scale value)		
	Voltage error	±0.5% (at the operating voltage changes between 85 to 110%)		
	Temperature error	±2% (at 20°C ambient temp. at the range of -10 to +50°C +14 to +122°F)		
Contact	Contact arrangement	Timed-out 2 Form C		Timed-out 1 Form C Instantaneous 1 Form C
	Contact resistance (Initial value)	Max. 100mΩ (at 1A 6V DC)		
	Contact material	Silver alloy		Au flash on Silver alloy
Life	Mechanical (contact)	2×10 ⁷		
	Electrical (contact)	10 ⁵ (at rated control capacity)		
Electrical function	Allowable operating voltage range	85 to 110% of rated operating voltage (at 20°C coil temp.)		
	Insulation resistance (Initial value)	Min. 100MΩ	Between live and dead metal parts Between input and output Between contacts of different poles Between contacts of same pole	(At 500V DC)
	Breakdown voltage (Initial value)	2,000Vrms for 1 min Between live and dead metal parts 2,000Vrms for 1 min Between input and output 2,000Vrms for 1 min Between contacts of different poles 1,000Vrms for 1 min Between contacts of same pole		
	Min. power off time	100ms		
	Max. temperature rise	55°C 131°F		65°C 149°F
Mechanical function	Vibration resistance	Functional	10 to 55Hz: 1 cycle/min double amplitude of 0.25mm (10min on 3 axes)	
		Destructive	10 to 55Hz: 1 cycle/min double amplitude of 0.375mm (1h on 3 axes)	
	Shock resistance	Functional	Min. 98m/s ² (4 times on 3 axes)	
		Destructive	Min. 980m/s ² (5 times on 3 axes)	
Operating condition	Ambient temperature	-10 to +50°C +14 to +122°F		
	Ambient humidity	30 to 85%RH (at 20°C 68°F, non-condensing)		
	Atmospheric pressure	860 to 1,060hPa		
	Ripple factor (DC type)	20%		
Others	Protective construction	IP65 on front panel (using rubber gasket ATC18002) <only for IP65 type>		
	Weight	100g 3.527 oz (Pin type) 110g 3.880 oz (Screw terminal type)		

Note: 1) Unless otherwise specified, the measurement conditions at the maximum scale time standard are specified to be the rated operating voltage (within 5% ripple factor for DC), 20°C 68°F ambient temperature, and 1s power off time.

2) For the 1s range, the tolerance for each specification becomes ±10ms.

Terminal layouts and Wiring diagrams

PM4H-A

Pin type

- Timed-out 2 Form C

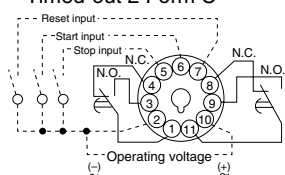

Screw terminal type

- Timed-out 2 Form C

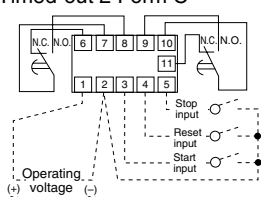

PM4H-S

Pin type

- Timed-out 2 Form C

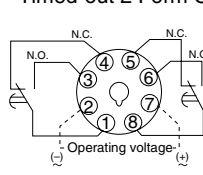

Screw terminal type

- Timed-out 2 Form C

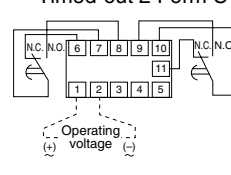

PM4H-M

Pin type

- Timed-out 1 Form C
- Instantaneous 1 Form C

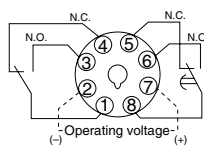

Screw terminal type

- Timed-out 1 Form C
- Instantaneous 1 Form C

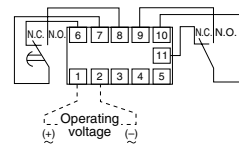

1) DC Type

Type	Pin	Screw terminal
PM4H-A	Connect the terminal ② to negative (-), and the terminal ⑩ to positive (+).	Connect the terminal ② to negative (-), and the terminal ① to positive (+).
PM4H-S	Connect the terminal ② to negative (-), and the terminal ⑦ to positive (+).	
PM4H-M	Connect the terminal ② to negative (-), and the terminal ⑦ to positive (+).	

2) Contact



- 3) Voltage should not be applied to the various inputs (reset, start, and stop) of the PM4H-A multi-range timer. These inputs should be input without voltage.

Parts name

PM4H-S



Time range selector

- 16 time settings selectable (1 s to 500 h)
- 1s 5s 10s 50s
- 1min 5min 10min 50min
- 1h 5h 10h 50h
- 10h 50h 100h 500h

PM4H-A

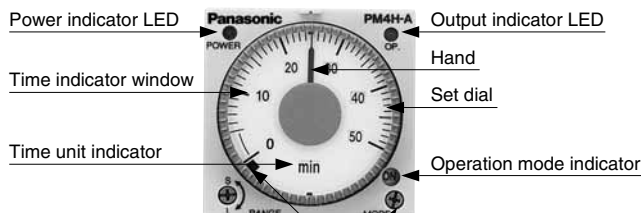

Instantaneous output area

When the hand is in this area, instantaneous operation starts.

Operation mode selector

- Selectable from 8 operation modes
- ON : Pulse ON-delay
- FL : Pulse Flicker
- FO : Pulse ON-flicker
- OF1 : Differential ON/OFF-delay (1)
- SF : Signal OFF-delay
- OS : Pulse One-shot
- OF2 : Differential ON/OFF-delay (2)
- OC : Pulse One-cycle

PM4H-M



Operation mode selector

- Selectable from 5 operation modes
- ON : Power ON-delay
- FL : Power flicker
- FO : Power ON-flicker
- OS : Power One-shot
- OC : Power One-cycle

PM4H-A/S/M

Dimensions

mm inch
Tolerance: $\pm 0.5 \pm 0.020$

• PM4H-□

Screw terminal type
(Flush mount)

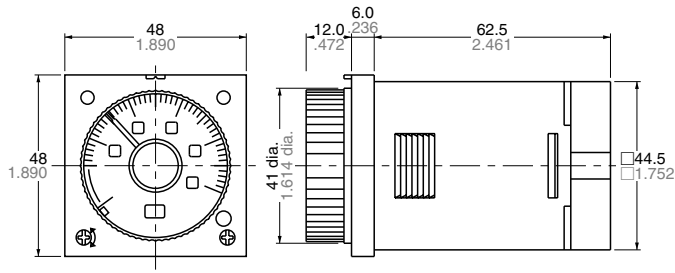

Pin type
(Flush mount/Surface mount)

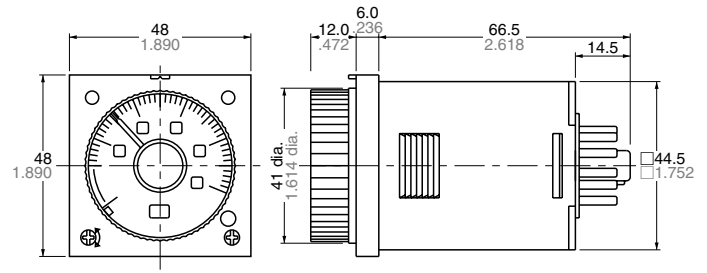

• Panel mount dimensions (with mounting frame)

Screw terminal type

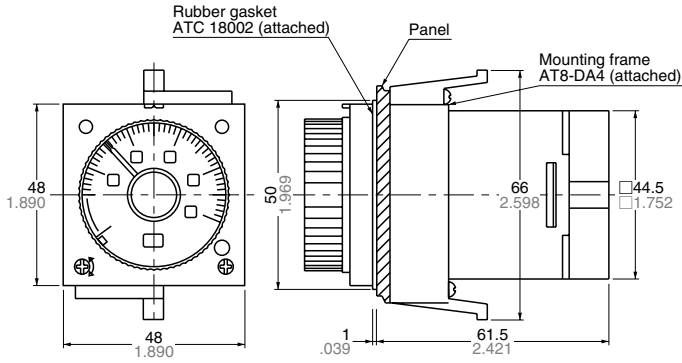

Pin type

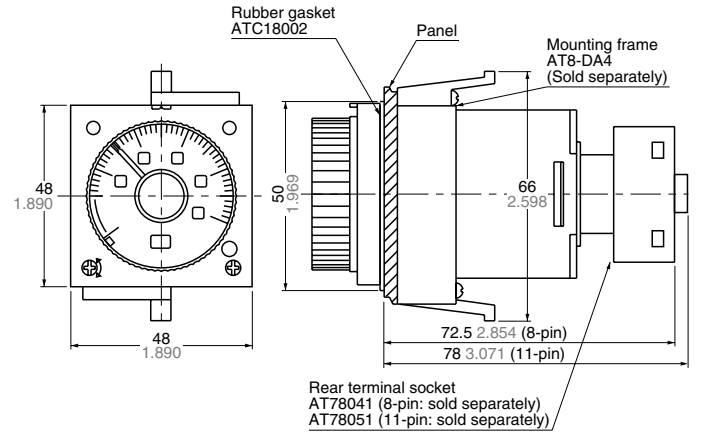

• Surface mount dimensions

Pin type

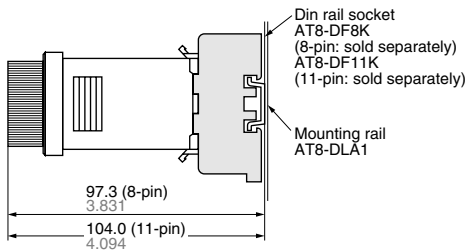

• Panel cut out dimensions

Standard cut out dimensions are shown below.
Use mounting frame (AT8-DA4) and rubber gasket (ATC18002).

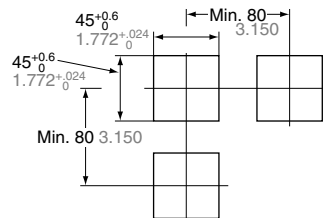

• Adjacent mounting

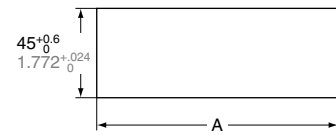

$$A = (48 \times n - 2.5) + 0.6$$

$$A = (1.890 \times n - .098) + 0.024$$

- Note) 1. The proper thickness of mounting panel is between 1 to 5mm.
2. Adjacent mount is less water-resistant.

Operation mode

PM4H-A

(* LED lighting ✱ LED flickering
T: Setting time $t_1, t_2, t_a, t_b < T$ $t_1+t_2=T$)

Operation type	Explanation	Time chart
<p>Pulse ON-delay</p> <p>(ON)</p>	<ul style="list-style-type: none"> If using a time-limit start when the power is turned on, and a reset when the power is turned off, pins ② to ⑥ (screw-tightening pins ② and ③) should be shorted ahead of time. Turn the operation mode selector switch to the (ON) position. If pins ② to ⑥ (screw-tightening pins ② and ③) are shorted (the start input is turned on) with the power supply on, the output will go on after the set time has elapsed. If the power supply is turned off, or pins ② to ⑦ (screw-tightening pins ② to ④) are shorted (the reset input is turned on), a reset is carried out. Note) During time-limited operation, the time-limited operation is stopped while the pins ② to ⑤ (screw-tightening pins ② to ⑤) are being shorted (the stop input is on). When the pins are released, time-limited operation resumes. 	<p>△Note: * LED lighting or No LED lighting</p>
<p>Pulse Flicker</p> <p>(FL)</p>	<ul style="list-style-type: none"> If using a time-limit start when the power is turned on, and a reset when the power is turned off, pins ② to ⑥ (screw-tightening pins ② and ③) should be shorted ahead of time. Turn the operation mode selector switch to the (FL) position. When pins ② to ⑥ (screw-tightening pins ② and ③) are shorted (the start input is turned on) with the power supply on, the limited time interval begins, and the output goes on after the set time has elapsed. After the output has gone on, it goes off when the set time has elapsed, and this process is subsequently repeated. If the power supply is turned off, or pins ② to ⑦ (screw-tightening pins ② to ④) are shorted (the reset input is turned on), a reset is carried out. Note) During time-limited operation, the time-limited operation is stopped while the pins ② to ⑤ (screw-tightening pins ② to ⑤) are being shorted (the stop input is on). When the pins are released, time-limited operation resumes. 	<p>△Note: * LED lighting or No LED lighting</p>
<p>Pulse ON-flicker</p> <p>(FO)</p>	<ul style="list-style-type: none"> If using a time-limit start when the power is turned on, and a reset when the power is turned off, pins ② to ⑥ (screw-tightening pins ② and ③) should be shorted ahead of time. Turn the operation mode selector switch to the (FO) position. When pins ② to ⑥ (screw-tightening pins ② and ③) are shorted (the start input is turned on) with the power supply on, the output goes on, and after the set time has elapsed, it goes off. This process is subsequently repeated. If the power supply is turned off, or pins ② to ⑦ (screw-tightening pins ② to ④) are shorted (the reset input is turned on), a reset is carried out. Note) During time-limited operation, the time-limited operation is stopped while the pins ② to ⑤ (screw-tightening pins ② to ⑤) are being shorted (the stop input is on). When the pins are released, time-limited operation resumes. 	<p>△Note: * LED lighting or No LED lighting</p>
<p>Differential ON/OFF-delay (1)</p> <p>(OF1)</p>	<ul style="list-style-type: none"> Turn the operation mode selector switch to the (OF1) position. When pins ② to ⑥ (screw-tightening pins ② and ③) are shorted (the start input is turned on) with the power supply on, the output goes on, and after the set time has elapsed, it goes off. Also, when pins ② to ⑥ are released (the start input goes off), the output goes on, and after the set time has elapsed, it goes off. If the status of pins ② to ⑥ (screw-tightening pins ② and ③) changes during the time-limit interval (the start input goes from on to off, or from off to on), the time-limit interval is restarted from the point at which the change took place. If the power supply is turned off, or pins ② to ⑦ (screw-tightening pins ② to ④) are shorted (the reset input is turned on), a reset is carried out. Note) During time-limited operation, the time-limited operation is stopped while the pins ② to ⑤ (screw-tightening pins ② to ⑤) are being shorted (the stop input is on). When the pins are released, time-limited operation resumes. 	<p>△Note: * LED lighting or No LED lighting</p>
<p>Signal OFF-delay</p> <p>(SF)</p>	<ul style="list-style-type: none"> Turn the operation mode selector switch to the (SF) position. When pins ② to ⑥ (screw-tightening pins ② and ③) are shorted (the start input is turned on) with the power supply on, the output goes on, and when pins ② to ④ (screw-tightening pins ② and ③) are released (the start input is turned off), the time limit interval begins. After the set time has elapsed, the output goes off. If start input is entered at any point during the time limit interval, the time limit interval is reset. Note) During time-limited operation, the time-limited operation is stopped while the pins ② to ⑤ (screw-tightening pins ② to ⑤) are being shorted (the stop input is on). When the pins are released, time-limited operation resumes. 	<p>△Note: * LED lighting or No LED lighting</p>

Note: Keep 0.1s or more for power off time.
Keep 0.05s or more for start, stop, reset input time.

PM4H-A/S/M

Operation type	Explanation	Time chart
Pulse One-shot OS	<ul style="list-style-type: none"> If using a time-limit start when the power is turned on, and a reset when the power is turned off, pins ② to ⑥ (screw-tightening pins ② and ③) should be shorted ahead of time. Turn the operation mode selector switch to the OS position. When pins ② to ⑥ (screw-tightening pins ② and ③) are shorted (the start input is turned on) with the power supply on, the output goes on for the set time limit interval. If the power supply is turned off, or pins ② to ⑦ (screw-tightening pins ② to ④) are shorted (the reset input is turned on), a reset is carried out. Note) During time-limited operation, the time-limited operation is stopped while the pins ② to ⑤ (screw-tightening pins ② to ⑤) are being shorted (the stop input is on). When the pins are released, time-limited operation resumes. 	<p>△Note: * LED lighting or No LED lighting</p>
Differential ON/OFF-delay (2) OF2	<ul style="list-style-type: none"> Turn the operation mode selector switch to the OF2 position. When pins ② to ⑥ (screw-tightening pins ② and ③) are shorted (the start input is turned on) with the power supply on, the time limit interval begins, and after the set time interval has elapsed, the output goes on. Also, when pins ② to ⑥ are released (the start input goes off), the time limit interval begins, and after it has elapsed, the output goes off. If the status of pins ② to ⑥ (screw-tightening pins ② and ③) changes during the time-limit interval (the start input goes from on to off, or from off to on), the time limit interval is restarted from the point at which the change took place. If the power supply is turned off, or pins ② to ⑦ (screw-tightening pins ② to ④) are shorted (the reset input is turned on), a reset is carried out. Note) During time-limited operation, the time-limited operation is stopped while the pins ② to ⑤ (screw-tightening pins ② to ⑤) are being shorted (the stop input is on). When the pins are released, time-limited operation resumes. 	<p>△Note: * LED lighting or No LED lighting</p>
Pulse One-cycle OC	<ul style="list-style-type: none"> If using a time-limit start when the power is turned on, and a reset when the power is turned off, pins ② to ⑥ (screw-tightening pins ② and ③) should be shorted ahead of time. Turn the operation mode selector switch to the OC position. When pins ② to ⑥ (screw-tightening pins ② and ③) are shorted (the start input is turned on) with the power supply on, the output goes on after the set time limit interval has elapsed. After it has gone on, it goes off after one pulse (approximately 0.8 seconds). If the power supply is turned off, or pins ② to ⑦ (screw-tightening pins ② to ④) are shorted (the reset input is turned on), a reset is carried out. Note) During time-limited operation, the time-limited operation is stopped while the pins ② to ⑤ (screw-tightening pins ② to ⑤) are being shorted (the stop input is on). When the pins are released, time-limited operation resumes. 	<p>One pulse time (t): Approx. 0.8s △Note: * LED lighting or No LED lighting</p>

Note: Keep 0.1s or more for power off time.
 Keep 0.05s or more for start, stop, reset input time.

PM4H-S

(* LED lighting *Δ LED flickering)
 T: Setting time

Operation type	Explanation	Time chart
Power ON-delay	Time limit contact relay When the power supply is turned on, the output goes on after the set time interval has elapsed. When the power supply is turned off, a reset is carried out.	

PM4H-M

Operation type	Explanation	Time chart
Power ON-delay ON Power Flicker FL Power ON-flicker FO Power One-shot OS Power One-cycle OC	Turn the operation mode selector switch to display the various operations. When the power supply is turned on, the time limit interval begins, and operation is carried out. When the power supply is turned off, a reset is carried out.	

Note: Keep 0.1s or more for power off time. PM4H-M timers do not have each input which is start, reset and stop.

Panasonic

ideas for life

DIN48 SIZE ANALOG
STAR (∟)-DELTA (Δ) TIMERS

PM4H-SD/SDM

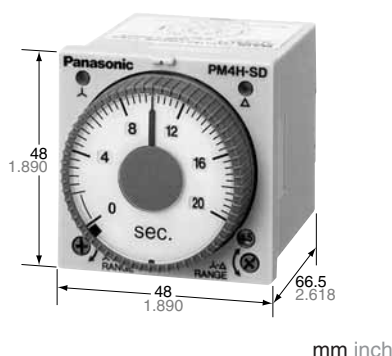

UL File No.: E122222
CSA File No.: LR39291



Features

1. Select four types of time ranges between 0.2 s and 100 s on a single unit.
2. Select between five types of time ranges between 0.04 s and 0.7 s for the ∟-Δ switching times.
3. There is a ∟-Δ switching indicator so you can check the operation at a glance.
4. The AC free power supply and shorter body make it easier to use.
5. Compliant with UL, CSA, CE and LLOYD.

RoHS Directive compatibility information
<http://www.nais-e.com/>

Specifications

Item	Type	PM4H-SD/SDM	
Rating	Rated operating voltage	100 to 240V AC, 24V AC	
	Rated frequency	50/60Hz common	
	Rated power consumption	Approx. 6VA (100 to 240V AC), Approx. 1.4VA (24V AC)	
	Rated control capacity	5A 250V AC (resistive load)	
	Operation mode	∟-Δ star-delta switching (Power ON-delay)	
	Operation control time range	2s to 100s, 4 time ranges switchable	
Time accuracy (Note:)	∟-Δ switching time	0.04, 0.1, 0.3, 0.5, 0.7s (5 time range selectable)	
	Operation time fluctuation	±0.3% (power off time change at the range of 0.5s to 1h)	
	Setting error	±5% (Full-scale value)	
	Voltage error	±0.5% (at the operating voltage changes between 85 to 110%)	
	Temperature error	±2% (at 20°C ambient temp. at the range of -10 to +50°C +14 to +122°F)	
Contact	Contact arrangement	Star (∟) side: Timed-out 1 Form A, Delta (Δ) side: Timed-out 1 Form A Instantaneous: 1 Form A (Instantaneous for PM4H-SDM type only)	
	Contact resistance (Initial value)	Max. 100mΩ (at 1A 6V DC)	
	Contact material	Au flash on Silver alloy	
Life	Mechanical (contact)	2×10 ⁷	
	Electrical (contact)	10 ⁵ (at rated control capacity)	
Electrical function	Allowable operating voltage range	85 to 110% of rated operating voltage (at 20°C coil temp.)	
	Insulation resistance (Initial value)	Min. 100MΩ Between live and dead metal parts Between input and output Between contacts of different poles (*3) (At 500V DC) Between contacts of same pole	
	Breakdown voltage (Initial value)	2,000Vrms for 1 min Between live and dead metal parts 2,000Vrms for 1 min Between input and output 2,000Vrms for 1 min Between contacts of different poles (*3) 1,000Vrms for 1 min Between contacts of same pole	
	Min. power off time	500ms	
	Max. temperature rise	65°C 131°F	
Mechanical function	Vibration resistance	Functional	10 to 55Hz: 1 cycle/min double amplitude of 0.25mm (10min on 3 axes)
		Destructive	10 to 55Hz: 1 cycle/min double amplitude of 0.375mm (1h on 3 axes)
	Shock resistance	Functional	Min. 294m/s ² (4 times on 3 axes)
		Destructive	Min. 980m/s ² (5 times on 3 axes)
Operating condition	Ambient temperature	-10 to +50°C +14 to +122°F	
	Ambient humidity	Max. 85%RH (non-condensing)	
	Atmospheric pressure	860 to 1,060hPa	
Others	Protective construction	IP65 on front panel (using rubber gasket ATC18002) <only for IP65 type>	
	Weight	100g 3.527 oz (Pin type), 110g 3.880 oz (Screw terminal type)	

Notes: 1) Unless otherwise specified, the measurement conditions at the maximum scale time standard are specified to be the rated operating voltage, 20°C 68°F ambient temperature, and 1s power off time.

2) For the 2s range, the tolerance for each specification becomes ±10ms.

3) Between contacts of different poles for PM4H-SDM type only.

PM4H-SD/SDM

Time range

Time range unit	Operating (s)	↘-Δ switching time (s)
2	0.2 to 2	0.04
10	1 to 10	0.1
20	2 to 20	0.3
100	10 to 100	0.7

Product types

Type	Operation mode	Contact arrangement	Time range	Protective construction	Rated operating voltage	Terminal type	Part number
PM4H-SD Star (↘)-Delta (Δ) switching	Star (↘)-Delta (Δ) switching	Relay Timed-out ↘ side: 1 Form A Δ side: 1 Form A	4 selectable ranges over 2s to 100s (↘-Δ switching time: 0.04, 0.1, 0.3, 0.5, 0.7s)	IP65	100 to 240V AC	8 pins	PM4HSD-S-AC240VW
						Screw terminal	PM4HSD-S-AC240VSW
24V AC		8 pins			PM4HSD-S-AC24VW		
		Screw terminal			PM4HSD-S-AC24VSW		
100 to 240V AC		8 pins			PM4HSDM-S-AC240VW		
					Screw terminal	PM4HSDM-S-AC240VSW	
24V AC		8 pins			PM4HSDM-S-AC24VW		
					Screw terminal	PM4HSDM-S-AC24VSW	
100 to 240V AC	8 pins	PM4HSD-S-AC240V					
		Screw terminal	PM4HSD-S-AC240VS				
24V AC	8 pins	PM4HSD-S-AC24V					
		Screw terminal	PM4HSD-S-AC24VS				
100 to 240V AC	8 pins	PM4HSDM-S-AC240V					
		Screw terminal	PM4HSDM-S-AC240VS				
24V AC	8 pins	PM4HSDM-S-AC24V					
		Screw terminal	PM4HSDM-S-AC24VS				

Terminal layouts and Wiring diagrams

Pin type

- No instantaneous contact
- With instantaneous contact

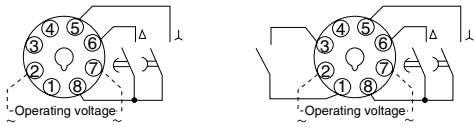

⑤-⑧: ↘ side time-delay contact
 ⑥-⑧: Δ side time-delay contact
 ①-③: Instantaneous contact
 (PM4H-SDM type)

Screw terminal type

- No instantaneous contact
- With instantaneous contact

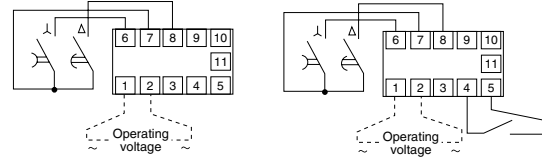

⑥-⑦: ↘ side time-delay contact
 ⑧-⑦: Δ side time-delay contact
 ④-⑤: Instantaneous contact
 (PM4H-SDM type)

Dimensions

mm inch

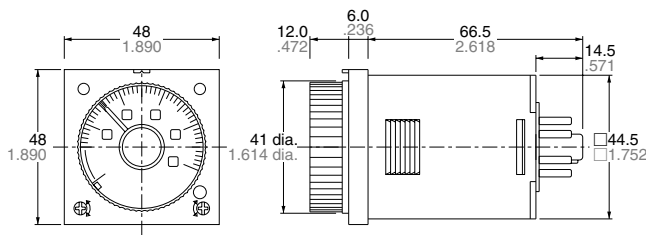

Operation

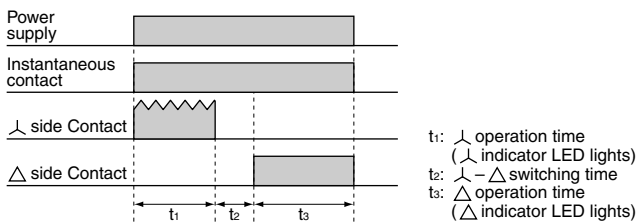

Panasonic
ideas for life

**DIN48 SIZE ANALOG
MULTIRANGE POWER
OFF-DELAY TIMERS**

PM4H-F

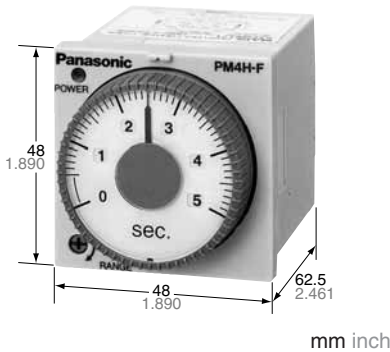

UL File No.: E122222
CSA File No.: LR39291



Features

1. Switch operation times between three types of time ranges of 1 s to 10 s and 1 min to 10 min.
2. Instantaneous reset available.
3. The shorter body makes it easier to use.
4. Compliant with UL, CSA, CE and LLOYD.

RoHS Directive compatibility information
<http://www.nais-e.com/>

Specifications

Item	Type	PM4H-F8	PM4H-F8R	PM4H-F11R
Rating	Rated operating voltage	100 to 120V AC, 200 to 240V AC, 24V DC, 12V DC, 24V DC		
	Rated frequency	50/60Hz common (AC operating type)		
	Rated power consumption	Approx. 1.6VA (100 to 120V AC, 200 to 240V AC), Approx. 2.3VA (24V AC) Approx. 1.1W (12V DC, 24V DC)		
	Rated control capacity	3A 250V AC (resistive load)		
	Operation mode	Power OFF-delay	Power OFF-delay (with reset)	
	Time range	1s to 10s: 3 range switchable 1 min to 10 min: 3 range selectable		
Time accuracy *1	Operation time fluctuation	±0.3%		
	Setting error	±5% (Full-scale value)		
	Voltage error	±0.5% (at the operating voltage changes between 85 to 110%)		
	Temperature error	±2% (at 20°C ambient temp. at the range of -10 to +50°C +14 to +122°F)		
Contact	Contact arrangement	Timed-out 2 Form C	Timed-out 1 Form C	Timed-out 2 Form C
	Contact resistance (Initial value)	Max. 100mΩ (at 1A 6V DC)		
	Contact material	Au flash on Silver alloy		
Life	Mechanical (contact)	10 ⁷		
	Electrical (contact)	10 ⁵ (at rated control capacity)		
Electrical function	Allowable operating voltage range	85 to 110% of rated operating voltage (at 20°C coil temp.), 90 to 110% (DC Type)		
	Insulation resistance (Initial value)	Min. 100MΩ	Between live and dead metal parts Between input and output Between contacts of different poles (*3) (At 500V DC) Between contacts of same pole	
	Breakdown voltage (Initial value)	1,500Vrms for 1 min Between live and dead metal parts 1,500Vrms for 1 min Between input and output 1,000Vrms for 1 min Between contacts of different poles (*3) 750Vrms for 1 min Between contacts of same pole		
	Min. power supply width	s range type: 100ms min range type: 2s		
	Min. reset time	50ms		
	Max. temperature rise	55°C 131°F		
Mechanical function	Vibration resistance	Functional	10 to 55Hz: 1 cycle/min double amplitude of 0.25mm (10min on 3 axes)	
		Destructive	10 to 55Hz: 1 cycle/min double amplitude of 0.375mm (1hr on 3 axes)	
	Shock resistance	Functional	Min. 98m/s ² (4 times on 3 axes)	
		Destructive	Min. 980m/s ² (5 times on 3 axes)	
Operating condition	Ambient temperature	-10 to +50°C +14 to +122°F		
	Ambient humidity	30 to 85%RH (non-condensing)		
	Atmospheric pressure	860 to 1,060hPa		
	Ripple factor (DC type)	20%		
Others	Protective construction	IP65 on front panel (using rubber gasket ATC18002) <only for IP65 type>		
	Weight	100g 3.527 oz (Pin type), 110g 3.880 oz (Screw terminal type)		

*Notes: 1) Unless otherwise specified, the measurement conditions at the maximum scale time standard are specified to be the rated operating voltage (within 5% ripple factor for DC), 20°C 68°F ambient temperature.
2) For the 1s range, the tolerance for each specification becomes ±10ms. When the power goes on, inrush current (0.3A) flows. Cautions should be taken. The minimum power supplying time after forced reset input is 2s or more.
3) Between contacts of different pools for PM4H-F8, PM4H-F11R types only.

PM4H-F

Time range

Time range	Time range unit	s range type	min range type
1		0.04s to 1s	0.04 min to 1 min
5		0.2s to 5s	0.2 min to 5 min
10		0.4s to 10s	0.4 min to 10 min

Product types

Type	Operation mode	Contact arrangement	Time range	Protective construction	Rated operating voltage	Terminal type	Part number
PM4H-F8	Power OFF-delay (without reset)	Relay Timed-out 2 Form C	3 selectable time ranges over 1s to 10s	IP65	100 to 120V AC	8 pins	PM4HF8-S-AC120VW
					200 to 240V AC	8 pins	PM4HF8-S-AC240VW
					24V AC	8 pins	PM4HF8-S-AC24VW
					12V DC	8 pins	PM4HF8-S-DC12VW
					24V DC	8 pins	PM4HF8-S-DC24VW
					100 to 120V AC	8 pins	PM4HF8-M-AC120VW
					200 to 240V AC	8 pins	PM4HF8-M-AC240VW
					24V AC	8 pins	PM4HF8-M-AC24VW
			3 selectable time ranges over 1 min to 10 min	IP65	12V DC	8 pins	PM4HF8-M-DC12VW
					24V DC	8 pins	PM4HF8-M-DC24VW
					100 to 120V AC	8 pins	PM4HF8-S-AC120V
					200 to 240V AC	8 pins	PM4HF8-S-AC240V
					24V AC	8 pins	PM4HF8-S-AC24V
					12V DC	8 pins	PM4HF8-S-DC12V
					24V DC	8 pins	PM4HF8-S-DC24V
					3 selectable time ranges over 1 min to 10 min	IP50	100 to 120V AC
			200 to 240V AC	8 pins			PM4HF8-M-AC240V
			24V AC	8 pins			PM4HF8-M-AC24V
			12V DC	8 pins			PM4HF8-M-DC12V
			24V DC	8 pins			PM4HF8-M-DC24V
100 to 120V AC	8 pins	PM4HF8-S-AC120V					
200 to 240V AC	8 pins	PM4HF8-S-AC240V					
24V AC	8 pins	PM4HF8-S-AC24V					
PM4H-F8R	Power OFF-delay (with instantaneous reset)	Relay Timed-out 1 Form C	3 selectable time ranges over 1s to 10s	IP65	100 to 120V AC	8 pins	PM4HF8R-S-AC120VW
					200 to 240V AC	8 pins	PM4HF8R-S-AC240VW
					24V AC	8 pins	PM4HF8R-S-AC24VW
					12V DC	8 pins	PM4HF8R-S-DC12VW
					24V DC	8 pins	PM4HF8R-S-DC24VW
					100 to 120V AC	8 pins	PM4HF8R-M-AC120VW
					200 to 240V AC	8 pins	PM4HF8R-M-AC240VW
					24V AC	8 pins	PM4HF8R-M-AC24VW
			3 selectable time ranges over 1 min to 10 min	IP65	12V DC	8 pins	PM4HF8R-M-DC12VW
					24V DC	8 pins	PM4HF8R-M-DC24VW
					100 to 120V AC	8 pins	PM4HF8R-S-AC120V
					200 to 240V AC	8 pins	PM4HF8R-S-AC240V
					24V AC	8 pins	PM4HF8R-S-AC24V
					12V DC	8 pins	PM4HF8R-S-DC12V
					24V DC	8 pins	PM4HF8R-S-DC24V
					3 selectable time ranges over 1 min to 10 min	IP50	100 to 120V AC
			200 to 240V AC	8 pins			PM4HF8R-M-AC240V
			24V AC	8 pins			PM4HF8R-M-AC24V
			12V DC	8 pins			PM4HF8R-M-DC12V
			24V DC	8 pins			PM4HF8R-M-DC24V
100 to 120V AC	8 pins	PM4HF8R-S-AC120V					
200 to 240V AC	8 pins	PM4HF8R-S-AC240V					
24V AC	8 pins	PM4HF8R-S-AC24V					
12V DC	8 pins	PM4HF8R-S-DC12V					
24V DC	8 pins	PM4HF8R-S-DC24V					

Type	Operation mode	Contact arrangement	Time range	Protective construction	Rated operating voltage	Terminal type	Part number
PM4H-F11R	Power OFF-delay (with instantaneous reset)	Relay Timed-out 2 Form C	3 selectable time ranges over 1s to 10s	IP65	100 to 120V AC	11 pins	PM4HF11R-S-AC120VW
						Screw terminal	PM4HF11R-S-AC120VSW
					200 to 240V AC	11 pins	PM4HF11R-S-AC240VW
						Screw terminal	PM4HF11R-S-AC240VSW
					24V AC	11 pins	PM4HF11R-S-AC24VW
						Screw terminal	PM4HF11R-S-AC24VSW
				12V DC	11 pins	PM4HF11R-S-DC12VW	
					Screw terminal	PM4HF11R-S-DC12VSW	
				24V DC	11 pins	PM4HF11R-S-DC24VW	
					Screw terminal	PM4HF11R-S-DC24VSW	
				IP50	100 to 120V AC	11 pins	PM4HF11R-S-AC120V
						Screw terminal	PM4HF11R-S-AC120VS
			200 to 240V AC		11 pins	PM4HF11R-S-AC240V	
					Screw terminal	PM4HF11R-S-AC240VS	
			24V AC		11 pins	PM4HF11R-S-AC24V	
					Screw terminal	PM4HF11R-S-AC24VS	
			12V DC	11 pins	PM4HF11R-S-DC12V		
				Screw terminal	PM4HF11R-S-DC12VS		
			24V DC	11 pins	PM4HF11R-S-DC24V		
				Screw terminal	PM4HF11R-S-DC24VS		
			3 selectable time ranges over 1 min to 10 min	IP65	100 to 120V AC	11 pins	PM4HF11R-M-AC120VW
						Screw terminal	PM4HF11R-M-AC120VSW
					200 to 240V AC	11 pins	PM4HF11R-M-AC240VW
						Screw terminal	PM4HF11R-M-AC240VSW
24V AC	11 pins	PM4HF11R-M-AC24VW					
	Screw terminal	PM4HF11R-M-AC24VSW					
12V DC	11 pins	PM4HF11R-M-DC12VW					
	Screw terminal	PM4HF11R-M-DC12VSW					
24V DC	11 pins	PM4HF11R-M-DC24VW					
	Screw terminal	PM4HF11R-M-DC24VSW					
IP50	100 to 120V AC	11 pins		PM4HF11R-M-AC120V			
		Screw terminal		PM4HF11R-M-AC120VS			
	200 to 240V AC	11 pins	PM4HF11R-M-AC240V				
		Screw terminal	PM4HF11R-M-AC240VS				
	24V AC	11 pins	PM4HF11R-M-AC24V				
		Screw terminal	PM4HF11R-M-AC24VS				
12V DC	11 pins	PM4HF11R-M-DC12V					
	Screw terminal	PM4HF11R-M-DC12VS					
24V DC	11 pins	PM4HF11R-M-DC24V					
	Screw terminal	PM4HF11R-M-DC24VS					

Dimensions

mm inch
Tolerance: ±0.5 ±.020

• Screw terminal type (Flush mount)

• Pin type (Flush mount/surface mount)

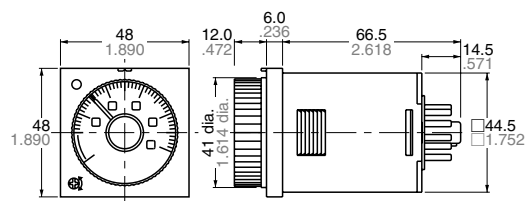
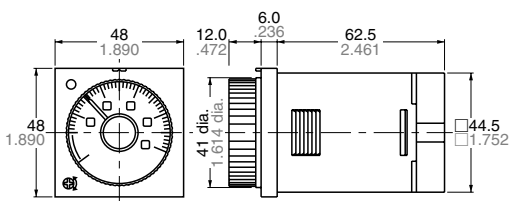

PM4H-F

Terminal layouts and Wiring diagrams

- **PM4H-F8 (without reset input)**

Pin type
Time-out 2 Form C

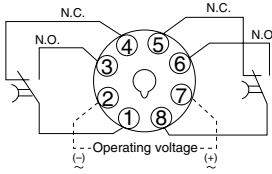

Screw-tightening pin type

The PM4H-F11R should be used for the time-limit 2C.

- **PM4H-F8R (with reset input)**

Pin type
Time-out 1 Form C, with reset input

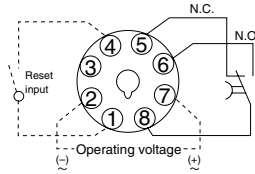

Screw-tightening pin type

The PM4H-F11R should be used for the time-limit 1C and to connect reset input.

- **PM4H-F11R (with reset input)**

Pin type
Time-out 2 Form C, with reset input

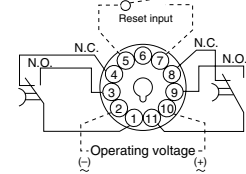

Screw terminal type

Time-out 2 Form C, with reset input

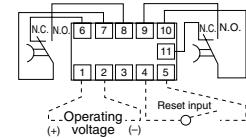

PM4H-F (with reset) input conditions

1. Contact input (pin type example)

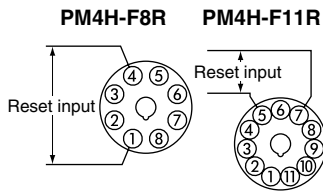

Use a contact with good contact reliability for the input. Contact bounce can lead to erroneous operation of the timer, so use a contact with short bounce time. Make the resistance between terminals for a short circuit less than 1k-ohms. Make the resistance between terminals for an open circuit greater than 100k-ohms.

2. Non-contact input (pin type example)

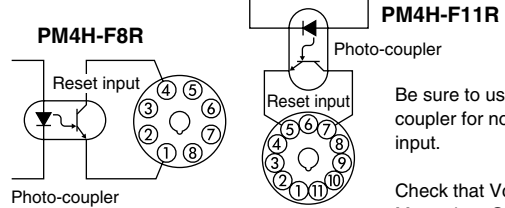

Be sure to use a photo-coupler for non-contact input.

Check that $V_{ce} = 0.6V$ Max. when ON.

Operation

- **PM4H-F8 (without reset input)**

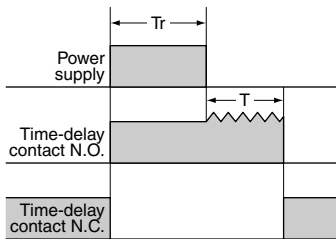

- **PM4H-F8R/F11R (with reset input)**

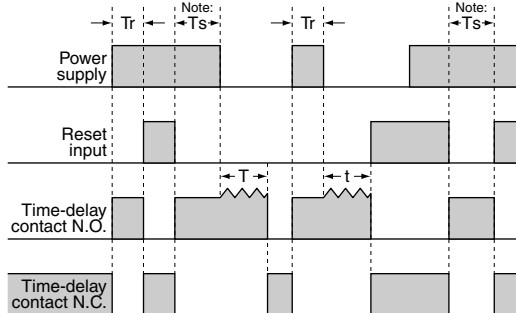

$t < T$: Time setting

T_r : Minimum power supply application time

Note: T_s : Min. 2s (Time to restart operation after reset input is set to OFF: both second type and minute type)

Panasonic
ideas for life

**DIN48 SIZE
ANALOG MULTI-RANGE
CYCLIC TWIN TIMERS**

PM4H-W

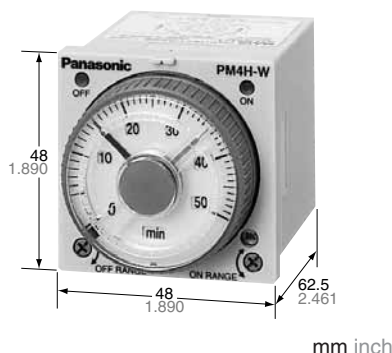

**UL File No.: E122222
CSA File No.: LR39291**



Features

1. A single twin timer unit that repeats (variable) ON/OFF.
2. Multiple ranges with a 0.1 s to 500 h time specification on a single unit.
3. The output ON/OFF operation is indicated by red and green LED's. It's easy to check the operation at a glance.
4. The AC free power supply and shorter body make it easier to use.
5. A new screw terminal type has been added to the conventional pin type. Wiring can be done easily with a screwdriver.
6. Compliant with UL, CSA, CE and LLOYD.

RoHS Directive compatibility information
<http://www.nais-e.com/>

Specifications

Item	Type	PM4H-W	
Rating	Rated operating voltage	100 to 240V AC, 48 to 125V DC, 12V DC, 24V AC/DC	
	Rated frequency	50/60Hz common (AC operating type)	
	Rated power consumption	Approx. 10VA (100 to 240V AC) Approx. 2.5VA (24V AC) Approx. 1.5W (12V DC, 24V DC, 48 to 125V DC)	
	Rated control capacity	5A 250V AC (resistive load)	
	Operation mode	Cyclic (OFF-start/Twin operation)	
	Time range	1s to 500h 16 time ranges switchable (T ₁ , T ₂ time setting individually)	
Time accuracy (Note:)	Operation time fluctuation	±0.3% (power off time change at the range of 0.3s to 1h)	
	Setting error	±5% (Full-scale value)	
	Voltage error	±0.5% (at the operating voltage changes between 85 to 110%)	
	Temperature error	±2% (at 20°C ambient temp. at the range of -10 to +50°C +14 to 122°F)	
Contact	Contact arrangement	Timed-out 2 Form C	
	Contact resistance (Initial value)	Max. 100mΩ (at 1A 6V DC)	
	Contact material	Silver alloy	
Life	Mechanical (contact)	2×10 ⁷	
	Electrical (contact)	10 ⁵ (at rated control capacity)	
Electrical function	Allowable operating voltage range	85 to 110% of rated operating voltage (at 20°C coil temp.)	
	Insulation resistance (Initial value)	Min. 100MΩ Between live and dead metal parts Between input and output Between contacts of different poles (At 500V DC) Between contacts of same pole	
	Breakdown voltage (Initial value)	2,000Vrms for 1 min Between live and metal parts 2,000Vrms for 1 min Between input and output 2,000Vrms for 1 min Between contacts of different poles 1,000Vrms for 1 min Between contacts of same pole	
	Min. power off time	300ms	
	Max. temperature rise	55°C 131°F	
Mechanical function	Vibration resistance	Functional	10 to 55Hz: 1 cycle/min double amplitude of 0.25mm (10min on 3 axes)
		Destructive	10 to 55Hz: 1 cycle/min double amplitude of 0.375mm (1h on 3 axes)
	Shock resistance	Functional	Min. 98m/s ² (4 times on 3 axes)
		Destructive	Min. 980m/s ² (5 times on 3 axes)
Operating condition	Ambient temperature	-10 to +50°C +14 to +122°F	
	Ambient humidity	30 to 85%RH (non-condensing)	
	Atmospheric pressure	860 to 1,060hPa	
	Ripple factor (DC type)	20%	
Others	Protective construction	IP65 on front panel (using rubber gasket ATC18002) <only for IP65 type>	
	Weight	120g 4.233 oz (Pin type), 130g 4.586 oz (Screw terminal type)	

Notes: 1) Unless otherwise specified, the measurement conditions at the maximum scale time standard are specified to be the rated operating voltage (within 5% ripple factor for DC), 20°C 68°F ambient temperature, and 1s power off time.

2) For the 1s range, the tolerance for each specification becomes ±10ms.

3) As internal components may become worn when using continuous conduction, the product should be replaced periodically.

PM4H-W

Time range

All types of PM4H-W timer have multi-time range.
16 time ranges are selectable.
1s to 500h (Max. range) is controlled.

Scale	Time unit	sec	min	hrs	10h
		Control time range	0.1s to 1s	0.1 min to 1 min	0.1h to 1h
1	Control time range	0.5s to 5s	0.5 min to 5 min	0.5h to 5h	5h to 50h
5		1.0s to 10s	1.0 min to 10 min	1.0h to 10h	10h to 100h
10		5s to 50s	5 min to 50 min	5h to 50h	50h to 500h
50					

Product types

Type	Operating mode	Contact arrangement	Time range	Protective structure	Rated Operating voltage	Terminal type	Part number
PM4H-W Twin timer	Cyclic (OFF-start, Twin)	Relay Timed-out 2 Form C	16 selectable ranges (1s to 500h)	IP65	100 to 240V AC	8 pins	PM4HW-H-AC240VW
						Screw terminal	PM4HW-H-AC240VSW
					48 to 125V DC	8 pins	PM4HW-H-DC125VW
						Screw terminal	PM4HW-H-DC125VSW
					24V AC/DC	8 pins	PM4HW-H-24VW
						Screw terminal	PM4HW-H-24VSW
					12V DC	8 pins	PM4HW-H-DC12VW
						Screw terminal	PM4HW-H-DC12VSW
				IP50	100 to 240V AC	8 pins	PM4HW-H-AC240V
						Screw terminal	PM4HW-H-AC240VS
					48 to 125V DC	8 pins	PM4HW-H-DC125V
						Screw terminal	PM4HW-H-DC125VS
					24V AC/DC	8 pins	PM4HW-H-24V
						Screw terminal	PM4HW-H-24VS
					12V DC	8 pins	PM4HW-H-DC12V
						Screw terminal	PM4HW-H-DC12VS

Terminal layouts and Wiring diagrams

Pin Type

Cyclic timed-out relay contact: 2C

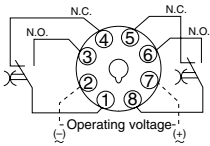

Screw terminal type

Cyclic timed-out relay contact: 2C

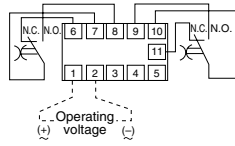

Dimensions

• Screw terminal type: M3.5

• Pin type

mm inch
Tolerance: $\pm 0.5 \pm 0.020$

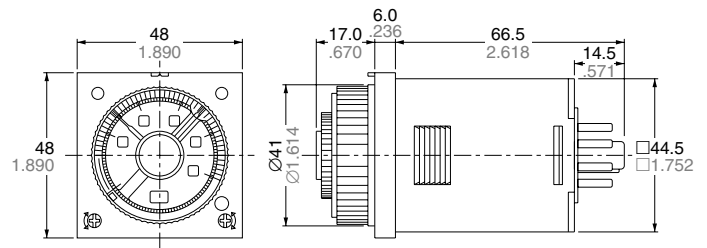
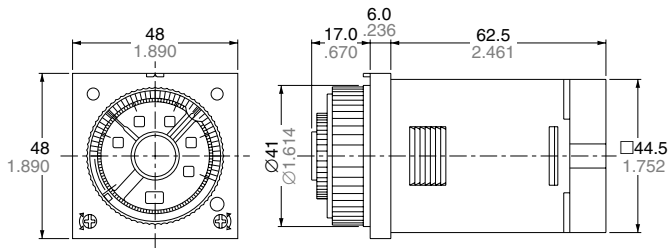

Operation

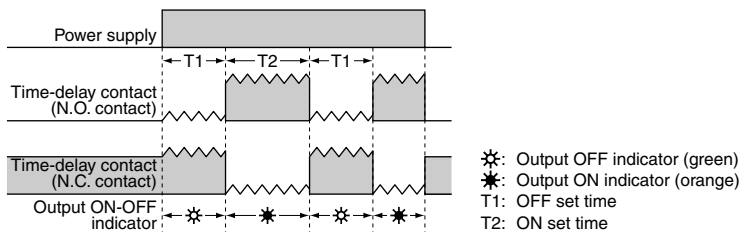

PM4H SERIES MODES AND TIME SETTING

1. Operation method

1) Operation mode setting [PM4H-A type]

8 operation modes are selectable with operation mode selector.
Turn the operation mode selector with screw driver.
Operation mode is shown up through the window above the mode selector. The marks are (ON), (FL), (FO), (OF), (SF), (OS), (PF), (OC).
Turn the mode selector to the mark until you can check by clicking sound.
Confirm the mode selector position if it is correct.
If the position is not stable, the timer might mis-operate.



2) Time range setting [PM4H series common]

16 time ranges are selectable between 1s to 500h.
Turn the time range selector with the screw driver.
Clockwise turning increases the time range, and Counter-clockwise turning decrease the time range.
Confirm the range selector position if it is correct.
If the position is not stable, the timer might mis-operate.



3) Time setting [common]

To set the time, turn the set dial to a desired time within the range.
Instantaneous output will be on when the dial is set to "0".
When the instantaneous output is used, the dial should be set under "0" range. (Instantaneous output area)
When power supply is on, the time range, setting time and operation mode cannot be changed.
Turn off the power supply or a reset signal is applied to set the new operation mode.
If the position is not stable, the timer might mis-operate.

2. How to use "Set ring" [PM4H series common]

1) Fixed time setting

Set the desired time and put 2 set rings together.
Insert the rings into stopper to fix the time.

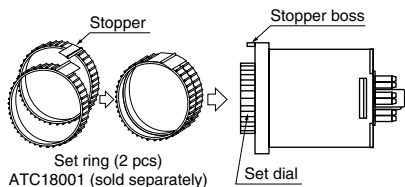

2) Time range setting

Example: Time range 20s to 30s.

① Shorter time value setting

Set the dial to 20s.
Place the stop ring at the right side of stopper.

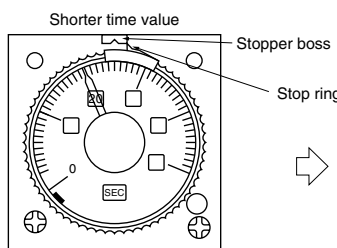

② Longer time value setting

Set the dial to 30s.
Place the stop ring at the left side of stopper.

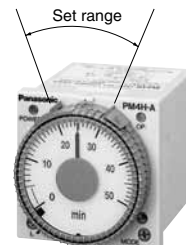
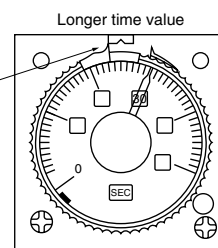

Note) The stoppers for the lower limit setting set ring and the upper limit setting set ring face the opposite directions.

Applicable standard (PM4H series common)

Safety standard	EN61812-1	Pollution Degree 2/Overvoltage Category III
EMC	(EMI)EN61000-6-4 Radiation interference electric field strength Noise terminal voltage (EMS)EN61000-6-2 Static discharge immunity	EN55011 Group1 ClassA EN55011 Group1 ClassA
	RF electromagnetic field immunity	EN61000-4-2 4 kV contact 8 kV air
	EFT/B immunity	EN61000-4-3 10 V/m AM modulation (80 MHz to 1 GHz) 10 V/m pulse modulation (895 MHz to 905 MHz)
	Surge immunity	EN61000-4-4 2 kV (power supply line) 1 kV (signal line)
	Conductivity noise immunity	EN61000-4-5 1 kV (power line)
	Power frequency magnetic field immunity	EN61000-4-6 10 V/m AM modulation (0.15 MHz to 80 MHz)
	Voltage dip/Instantaneous stop/Voltage fluctuation immunity	EN61000-4-8 30 A/m (50 Hz) EN61000-4-11 10 ms, 30% (rated voltage) 100 ms, 60% (rated voltage) 1,000 ms, 60% (rated voltage) 5,000 ms, 95% (rated voltage)

PRECAUTIONS IN USING THE PM4H SERIES

1. Input connections (PM4H-A type)

1) Be sure not to use terminal ⑩ as the common terminal of the input signal as shown in Fig. A. Otherwise, the internal circuit of the timer may be damaged. Use terminal ② as the common terminal as shown in Fig. B.

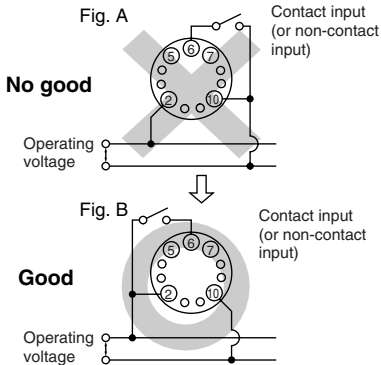

If the circuit is connected as in Fig. C, the internal circuits must be broken. Be sure to connect the circuit as in Fig. D.

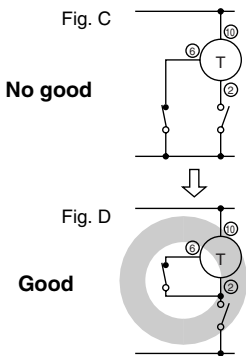

2) When one input signal is simultaneously applied to more than one timer, be sure to avoid the wiring shown in Fig. E. Otherwise, the short-circuit current will flow and cause damage. Be sure to align the polarity of the power supply as shown in Fig. F.

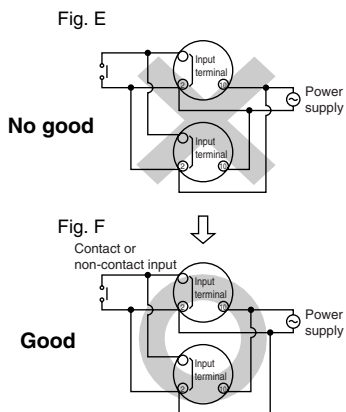

3) Terminal ②-⑥ (screw terminal ②-③) should be connected as the start input. Connect terminals ②-⑦ (screw terminal ②-④) for reset signal input. Connect terminals ②-⑤ (screw terminal ②-⑤) for stop signal input. Be sure not to connect with other terminals and apply excessive voltage. The internal circuit will be damaged.

4) The input wiring other than the power supply circuit should avoid these conditions, high-voltage wiring and parallel wiring with power wire. Wire in short with using the shielding wire or metal wiring tube.

5) For start, reset and stop input, use gold-plated contact with high reliability. Since contact bouncing causes errors in the start, use an input contact less bounce time.

6) Keep the minimum signal input time over 0.05 s.

2. Input signal conditions (PM4H-A type)

1) Connection of contact input (Pin type example)

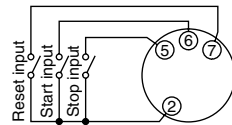

Use gold-plated contacts with high-reliability. The bounce time at the contacts causes errors in the timer operation time. Accordingly, use start input contact whose bounce time is short. The resistance when shorted should be less than 1k Ω , and when open resistance should be more than 100k Ω .

For the screw terminal type, connect the terminal ② to the each input signal.

2) Connection of non-contact input (Pin type example) (open-collector)

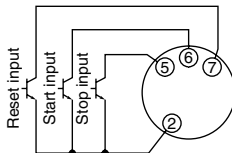

Apply the open-collector connection. The characteristics of the transistor used must be $V_{CE0}=10V$ or more, $I_C=10mA$ or more, and $I_{CBO}=6\mu A$ or less. Additionally, the input impedance must be 1k Ω or less, and the residual voltage must be 0.6V or less.

For the screw terminal type, connect the terminal ② to the each input signal.

3) Connection of non-contact input (Pin type example) (voltage input)

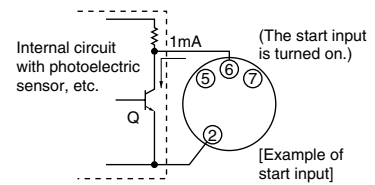

Even if the open collector is not used, input is also possible from the non-contact circuit of 6 to 30V DC. In this case, the start input is turned on when the signal is turned from H to L.

The residual voltage must be 0.6V or less when Q is on. On the AC type, an insulated transformer is required as the power supply for the photoelectric sensor, etc. (power supply for the input devices).

Note: Keep the minimum input signal time of each signal to 0.05s or more.

3. Checking the contacts before use (PM4H-F only)

When the power ON time is less than the minimum power application time, the contacts may remain in an ON state, so the state of the contacts should be checked before use. When the contacts are in an ON state, activating them once will return them to their normal state (the OFF state after time-out). (Be aware that relay characteristics may result in the contacts being in that same ON state if exposed to excessive vibration and impact during transport.)

4. Time setting

To set the time, turn the set dial to a desired time within the range. Instantaneous output will be on when the dial is set to "0".

When the instantaneous output is used, the dial should be set under "0" range. (Instantaneous output area)

Note) When power supply is on, the time range, setting time and operation mode cannot be changed.

Turn off the power supply or a reset signal is applied to set the new operation mode.

If the position is not stable, the timer might mis-operate.

PRECAUTIONS IN USING THE PM4H SERIES

5. Superimposed surge of power supply (PM4H series common)

For the superimposed surge of power supply, the standard waveform is taken as the standard value for surge-proof voltage.

If external surge occurs exceeding the specified value, the internal circuit may break down. In this case, use a surge absorption element.

Operation voltage	Surge voltage
100 to 240V AC 100 to 120V AC 200 to 240V AC 48 to 125V DC	4,000V
12V DC, 24V DC 24V AC/DC	500V

The positive and negative voltages are applied each five times between the power pins.

The typical surge absorption elements include a varistor, a capacitor, and a diode. If a surge absorption element is used, use an oscilloscope to see whether or not the foreign surge exceeding the specified value appears.

6. Acquisition of CE marking

Please abide by the conditions below when using in applications that comply with EN61812-1.

1) Overvoltage category III, pollution level 2

2) This timer employs a power supply without a transformer, so the power and input signal terminals are not insulated.

(PM4H-A only)

(1) When a sensor is connected to the input circuit, install double insulation on the sensor side.

(2) In the case of contact input, use dual-insulated relays, etc.

3) The load connected to the output contact should have basic insulation.

This timer is protected with basic insulation and can be double-insulated to meet EN/IEC requirements by using basic insulation on the load.

4) Please use a power supply that is protected by an overcurrent protection device which complies with the EN/IEC standard (example: 250 V 1 A fuse, etc.).

5) You must use a terminal socket or socket for the installation. Do not touch the terminals or other parts of the timer when it is powered. When installing or un-installing, make sure that no voltage is being applied to any of the terminals.

6) Do not use this timer as a safety circuit. For example when using a timer in a heater circuit, etc., provide a protection circuit on the machine side.

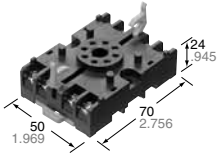
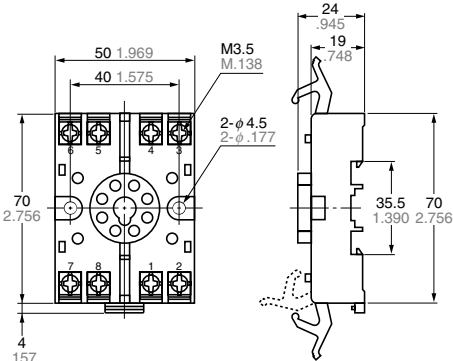
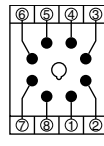
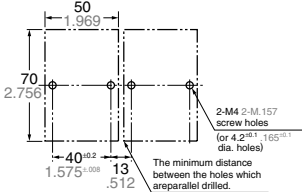
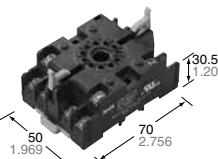
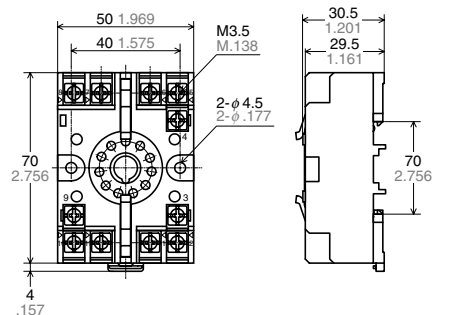
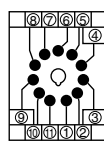
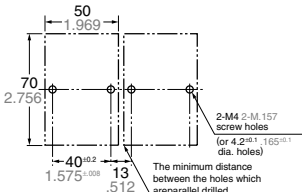

DIN SIZE TIMERS COMMON OPTIONS

Terminal sockets (Unit: mm inch, Tolerance: $\pm 1 \pm .039$)

Type	Appearance	Dimensions	Terminal wiring (Top view)	Mounting hole dimensions
PM4H-S PM4H-M PM4H-SD PM4H-F8 PM4H-F8R PM4H-W LT4H LT4H-L LT4H-W QM4H PM4S (8-pin type)	<ul style="list-style-type: none"> DIN rail socket (8-pin)  <p>ATC180031</p>		 <p>Note: Terminal No. on the main body are identical to those on the terminal socket.</p>	
PM4H-A PM4H-F11R LT4H LT4H-W (11-pin type)	<ul style="list-style-type: none"> DIN rail socket (11-pin)  <p>ATC180041</p>		 <p>Note: Terminal No. on the main body are identical to those on the terminal socket.</p>	

Note: The socket's numbering system matches that of the timer terminals.

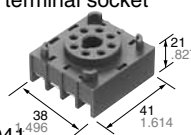
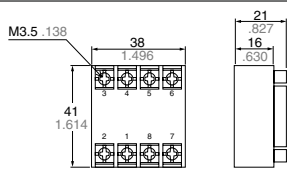
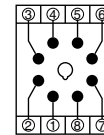
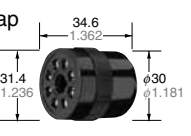
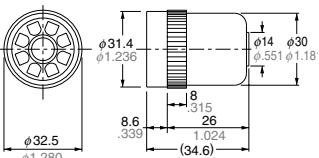
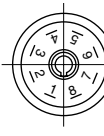
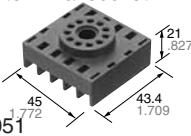
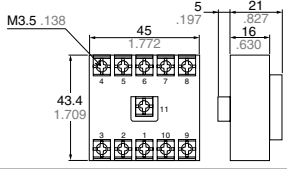
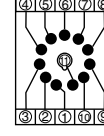
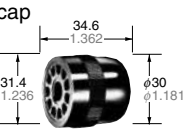
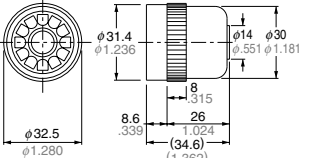
Sockets (Unit: mm inch, Tolerance: $\pm 1 \pm .039$)

Type	Appearance	Dimensions	Terminal wiring (Top view)	Mounting hole dimensions
PM4H-S PM4H-M PM4H-SD PM4H-F8 PM4H-F8R PM4H-W LT4H LT4H-L LT4H-W (8-pin type) PM4S QM4H	<ul style="list-style-type: none"> Rear terminal socket  <p>AT78041</p>			—
8P cap LT4H-L LT4H-W (8-pin type) PM4S QM4H	<ul style="list-style-type: none"> 8P cap  <p>AD8-RC</p>			—
PM4H-A PM4H-F11R LT4H LT4H-W (11-pin type)	<ul style="list-style-type: none"> Rear terminal socket  <p>AT78051</p>			—
11P cap	<ul style="list-style-type: none"> 11P cap  <p>AT8-DP11</p>			—

Note: The terminal socket's numbering system matches that of the timer terminals.

MOUNTING PARTS

• Rubber gasket

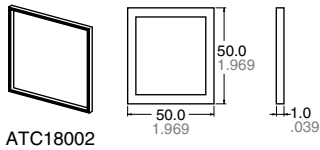

ATC18002

Applicable for PM4H series and LT4H series

The rubber gasket is enclosed in the PM4H (screw terminal type) and the LT4H series.

• Mounting frame

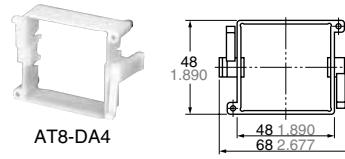

AT8-DA4

Applicable for PM4H series LT4H series and QM4H series

• Mounting rails (Applicable for DIN and IEC standards)



AT8-DLA1
Length: 1 m
aluminum

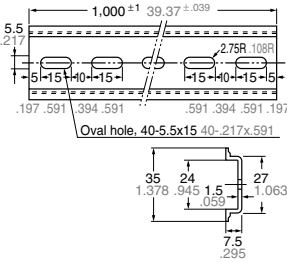

• Fastening plate



ATA4806

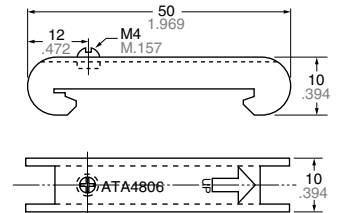

For holding DIN rails

• Protective cover for DIN 48 size: LT4H, QM4H series

Flexible type

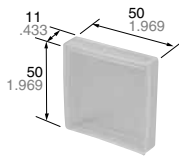

AQM4803

• Protective cover for DIN 48 size: QM4H series

Hard type

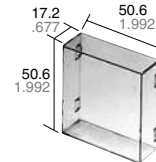

AQM4801

Accessories

PM4H series

• Panel cover (Black)

PM4H-A



ATC18011

PM4H-S



ATC18012

PM4H-M



ATC18013

PM4H-W



ATC18014

PM4H-SD



ATC18015

PM4H-F



ATC18016

LT4H series

• Panel cover (Black)

LT4H



ATL58011

LT4H-W



ATL68011

The black panel cover is also available so that you can change the appearance of the panel by changing the panel cover. The color of the standard panel cover is ash gray.

• Set ring

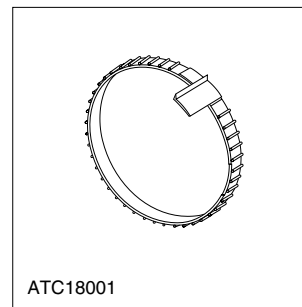

ATC18001

When you control the fixed time range, the setting rings (a set of 2 pcs.) make it easy to do the time setting and keep the time range all the time. (Excluding PM4H-W)

INSTALLING DIN SIZE TIMER

Installations

1. Surface mount

1) For the timers of PM4H and LT4H series, use the pin type timer. With the PM4S and QM4H series, only pin-type timers are available.

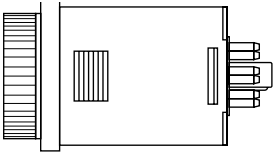

- 2) Put the terminal socket on the board directly or put it on the DIN rail (Fig. 1).
- 3) Insert the timer into the terminal socket and fix it with clip (Fig. 2)
- 4) On DIN rail mounting, mount the timer on the DIN rail tightly to get the proper dimension (Fig. 3).

(Fig. 1)

(Fig. 2)

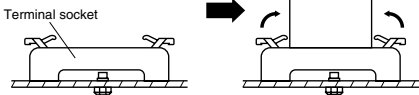

(Fig. 3)

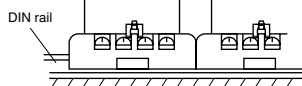

5) 8-pin type should be connected with terminal socket (AT8-DF8K). 11-pin type should be connected with terminal socket (AT8-DF11K).

6) DIN rail (AT8-DLA1) is also available (1 m).

2. Flush mount

1) For the timers of PM4H and LT4H series, it is recommended to use the built-in screw terminal type for flush mount. (Mounting frame and rubber gasket are provided when timer is shipped.)

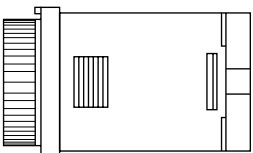

If the pin type is used, the mounting frame (AT8-DA4) and rubber gasket (ATC18002 for surface waterproofing) that are available at extra costs are necessary. If the pin connection socket is the 8-pin type, use the 8P cap (AD8-RC); or if it is the 11-pin type, use the 11P cap (AT8-DP11).

2) How to mount the timer

From the panel front, pass the timer through the square hole. Fit the mounting frame from the rear, and then push it in so that the clearance between the mounting frame and the panel surface is minimized. In addition, lock the mounting frame with a screw.

• Screw terminal type

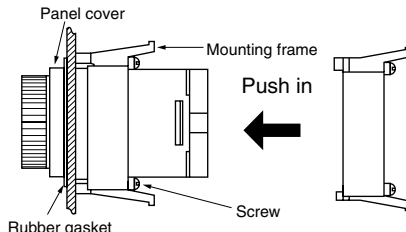

• Pin type

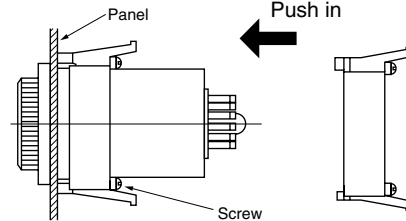

3) Caution in mounting the timer

• PM4H, and LT4H series

(a) If the PM4H and the LT4H series are used as the waterproof types, tighten the reinforcing screws on the mounting frames so that the timers, the rubber gaskets, and the panel surfaces are tightly contacted with each other. (Tighten the two screws with uniform force and make sure that there is no rattling. If the screws are tightened too excessively, the mounting frame may come off.)

(b) If the timer is installed with the panel cover and the rubber gasket removed, the waterproofing characteristic is lost.

(b) If the timer is installed with the panel cover and the rubber gasket removed, the waterproofing characteristic is lost.

4) Installation

Loosen the screws on the mounting frame, spread the edge of frame and remove it.

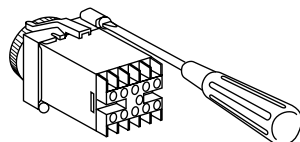

Pull the mounting frame backward while spreading out its hooks with your thumbs and index fingers.

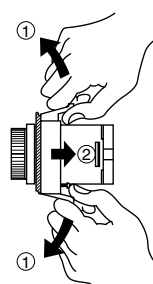

5) Correctly connect the pins while seeing the pin connection diagram.

Tighten the terminal screws with a torque of 0.8 N·cm or less. The screws are M3.5. (screw-tightened terminal type)

6) If the pin type is used, the rear terminal block (ATC78041) or the 8P cap (AD8-RC) is necessary to connect the pins. For the 11-pin type, use the rear terminal block (ATC78051) or the 11P cap (AT8-DP11) and avoid directly soldering the round pins on the timer.

7) Panel cutout dimensions

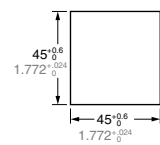

The standard panel cutout dimensions are shown in the left figure. (Panel thickness: 1 to 5 mm .039 to .197 inch)

8) Although the timers can be mounted adjacent to each other in this case, it is recommended to arrange the mounting holes as shown in the right figure to facilitate attaching and detaching the mounting frame.

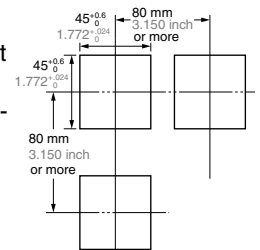

9) Adjacent mounting
Although the timers can be mounted adjacent to each other, remember that the panel surface of PM4H or LT4H series timer will lose its water-resistant effect. (Panel thickness: 1 to 5 mm .039 to .197 inch)







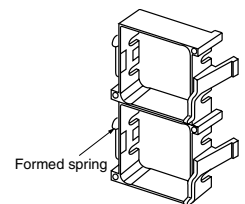
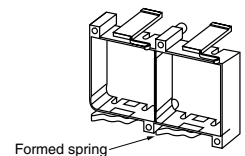









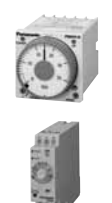
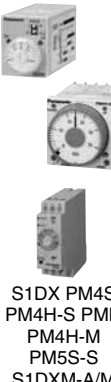
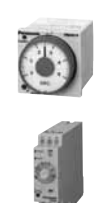

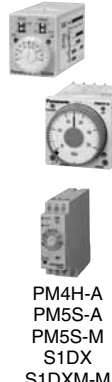
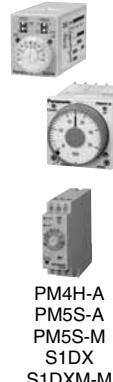
$$A = (48 \times n - 2.5)^{+0.6} \text{ (mm)}$$













When lining up the timers horizontally, set the frames in such a position so the formed spring areas are at the top and bottom. When lining up the timers vertically, set the frames in such a position so the formed spring areas are at the right and left.









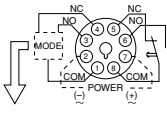
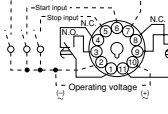
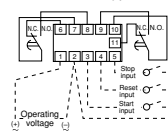
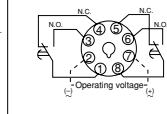
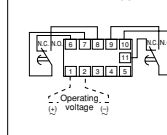
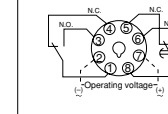
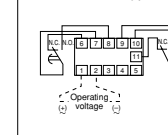
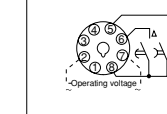
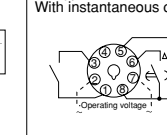
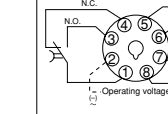
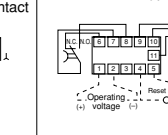





TIMERS CHART

		Multiple operation	ON-delay	OFF-delay	Twin	Flicker	One-shot	Star delta	One-cycle	Integration
Digital quartz timer	Surface mount/Flush mount	 LT4H LT4H-L LT4H-W	 LT4H LT4H-L QM4H	 LT4H (Signal) LT4H-L	 LT4H-W	 LT4H LT4H-L	 LT4H LT4H-L			 LT4H LT4H-L
	Multi-range analog timer (CR oscillation)	 PM4H-A PM5S-A	 S1DX PM4S PM4H-S PMH PM4H-M PM5S-S S1DXM-A/M	 PM4H-A (Signal) PM4H-F PM5S-A (Signal) PM5S-M (Signal)	 PM4H-W	 PM4H-A PM5S-A PM5S-M S1DX S1DXM-M	 PM4H-A PM5S-A PM5S-M S1DX S1DXM-M	 PM4H-SD/SDM	 S1DX	
Multi-range analog timer (CR oscillation)	Relay terminal socket		 S1DX S1DXM-A/M			 S1DX S1DXM-M	 S1DX S1DXM-M			 S1DX
	PC board mount		 S1DX							
Motor drive timer	Surface mount/Flush mount		 MHP MHP-M							

TIMERS SELECTOR CHART

Operation mode		Power ON-delay	Pulse ON-delay Pulse Flicker Pulse ON-Flicker Differential ON/OFF-delay (1)(2) Signal OFF-delay Pulse One-shot Pulse One-cycle	Power ON-delay	Power ON-delay Power Flicker Power ON-flicker Power One-shot Power One-cycle (with instantaneous contact)	Star-Delta	Power OFF-delay
Major uses		For time control for short or long time	For time control for short or long time	For time control for short or long time	For self holding circuit	For SD motor start-up	For all uses of power OFF-delay
Time range		CR oscillation counting timer					
1000h 100h 30h 10h 1h 30m 10m 5m 2m 1m 30s 10s 5s 1s 0.1s 0.01s Each model has various time ranges. See the product lists before ordering.		500h 16 time ranges selectable 0.1s		100s 4 time ranges selectable 0.2s		10min 3 time ranges selectable 0.04min 3 time ranges selectable 0.04s	
Model/Product Name		 PM4S Multi-range analog timer	 PM4H-A Multi-range analog timer	 PM4H-S Multi-range analog timer	 PM4H-M Multi-range analog timer	 PM4H-SD/SDM Star-Delta timer	 PM4H-F8/-F8R/-F11R OFF-delay timer
Features		An affordable new series timers	16 time ranges are selectable. 1s to 500h (Max. range) is controlled. 8 operation modes available.	16 time ranges are selectable. 1s to 500h (Max. range) is controlled in one unit.	16 time ranges are selectable. 1s to 500h (Max. range) is controlled in one unit. 5 operation modes (with instantaneous contact) available.	4 time ranges are selectable. 2s to 100s (Max. range) is controlled in one unit. 5 time ranges selectable for the Δ - Δ switching times.	Multiple time ranges are selectable. Power-OFF delay of max. 10 min. is controlled.
Control output (resistive)	Current	7A 5A 3A	5A	5A	5A	5A	3A
	Voltage	250 V AC	250 V AC	250 V AC	250 V AC	250 V AC	250 V AC
Mounting method							
Mounting parts		Terminal block, cap	Terminal block, cap, panel cover, rubber gasket, mounting frame	Terminal block, cap, panel cover, rubber gasket, mounting frame	Terminal block, cap, panel cover, rubber gasket, mounting frame	Terminal block, cap, panel cover, rubber gasket, mounting frame	Terminal block, cap, panel cover, rubber gasket, mounting frame
Rated operating voltage		100 to 120 V AC, 200 to 240 V AC, 12 V DC 24 V DC	100 to 240 V AC, 48 to 125V DC, 24 V AC/DC, 12 V DC (other models)	100 to 240 V AC, 48 to 125V DC, 24 V AC/DC, 12 V DC (other models)	100 to 240 V AC, 48 to 125V DC, 24 V AC/DC, 12 V DC (other models)	100 to 240 V AC, 24 V AC (other models)	100 to 120 V AC, 200 to 240 V AC, 12 V DC, 24 V DC, 24 V AC (other models)
Arrangement		T.D: Timed-out 2 Form C INST: Timed-out 1 Form C, instantaneous 1 Form C Selected by front switch	Timed-out 2 Form C	Timed-out 2 Form C	Timed-out 1 Form C Instantaneous 1 Form C	Δ side: Timed-out 1 Form A Δ side: Timed-out 1 Form A Instantaneous: 1 Form A	Timed-out 2 Form C Timed-out 1 Form C [F8R type]
Time accuracy	Operation time fluctuation	$\pm 1\%$ (power off time change at the range of 0.1s to 1h)	$\pm 0.3\%$	$\pm 0.3\%$	$\pm 0.3\%$	$\pm 0.3\%$	$\pm 0.3\%$
	Temperature error	$\pm 2\%$ (at 20°C ambient temp. at the range of -10 to +50°C)	$\pm 2\%$	$\pm 2\%$	$\pm 2\%$	$\pm 2\%$	$\pm 2\%$
	Voltage error	$\pm 1\%$ (at the operating voltage changes between 85 to 110%)	$\pm 0.5\%$	$\pm 0.5\%$	$\pm 0.5\%$	$\pm 0.5\%$	$\pm 0.5\%$
	Setting error	$\pm 5\%$	$\pm 5\%$	$\pm 5\%$	$\pm 5\%$	$\pm 5\%$	$\pm 5\%$
Min. power off time		100 ms	100 ms	100 ms	100 ms	500 ms	—
Life (Min. operation)	Mechanical	10^7	2×10^7	2×10^7	2×10^7	2×10^7	10^7
	Electrical	10^5	10^5	10^5	10^5	10^5	10^5
Terminal layouts and wiring diagrams		Pin type  T.D: Timed-out 2 Form C INST: Timed-out 1 Form C, instantaneous 1 Form C * Selected by front switch	Pin type  Screw terminal type 	Pin type  Screw terminal type 	Pin type  Screw terminal type 	Pin type No instantaneous contact  Pin type With instantaneous contact 	Pin type  Screw terminal type 
Available standards		UL/c-UL, CE	UL/CSA, CE, LLOYD	UL/CSA, CE, LLOYD	UL/CSA, CE, LLOYD	UL/CSA, CE, LLOYD	UL/CSA, CE, LLOYD
Page		P. 13	P. 17	P. 17	P. 17	P. 23	P. 25

TIMERS SELECTOR CHART

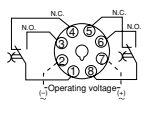
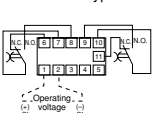
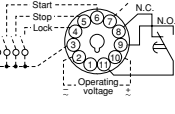
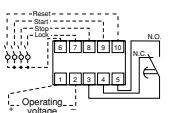
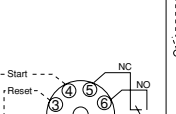
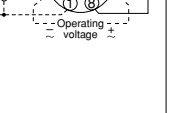
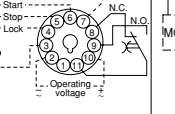
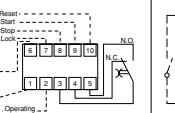
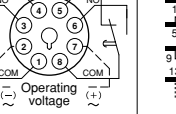
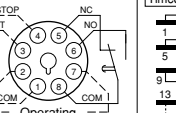
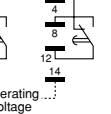
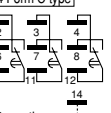
Operation mode		Power OFF-start cyclic	Power ON delay (1) Power ON delay (2) Signal ON delay Signal OFF delay Pulse One-shot Pulse ON-delay Signal Flicker Totalizing ON-delay	Power ON delay (1) Power ON delay (2) Signal ON delay Signal OFF delay Pulse One-shot Pulse ON-delay Signal Flicker Totalizing ON-delay	ON-start flicker OFF-start flicker Delay one-shot	Power ON-delay	Power ON-delay Power flicker Power One-shot
Major uses		CR oscillation counting timer For repetitive ON/OFF operation	Quartz oscillation counting timer Suitable for super-high accurate, digital setting				CR oscillation counting timer For highly accurate time setting
Time range		1000h 100h 30h 10h 1h 30m 10m 5m 2m 1m 30s 10s 5s 1s 0.1s 0.01s	999.9h 8 time ranges selectable	999.9h 8 time ranges selectable	9999h 8 time ranges selectable	9990h	10min 30min 60min 10h 3s
Model/Product Name		 PM4H-W Analog multi-range cyclic twin timer	 LT4H Digital timer	 LT4H-L Digital timer	 LT4H-W Digital timer	 QM4H Timer	 S1DXM-A/M Timer
Features		16 time ranges are selectable. 1s to 500h (Max. range) is controlled in one unit.	Bright and easy-to-read display Simple operation Short body	Economically price. Display is a bright reflective-type LCD.	Bright and easy-to-read display Simple operation Wide time setting range	Possible to set and change the time with front digit switches easily during the power off. Furthermore single unit has a time range of 0.01s to 9990hrs!!	With a large transparent dial. This timer can be attached both on the DIN rails and panel.
Control output (resistive)	Current	7A 5A 3A	(Relay output type) 5A (Transistor output type) 100mA	(Relay output type) 5A (Transistor output type) 100mA	(Relay output type) 5A (Transistor output type) 100mA	5A	7A 2 Form C type 5A 4 Form C type
	Voltage	250 V AC	250 V AC 30 V DC	250 V AC 30 V DC	250 V AC 30 V DC	250 V AC 30 V DC	250 V AC
Mounting method							
Mounting parts		Terminal block, cap, panel cover, rubber gasket, mounting frame	Terminal block, cap, panel cover, rubber gasket, mounting frame	Terminal block, cap, panel cover, rubber gasket, mounting frame	Terminal block, cap, panel cover, rubber gasket, mounting frame	Terminal block, cap, panel cover, rubber gasket, mounting frame	Terminal block, cap block, mounting frame, fitting sockets, protective cover
Rated operating voltage		100 to 240 V AC, 48 to 125V DC, 24 V AC/DC, 12 V DC (other models)	100 to 240 V AC 24 V AC 12 to 24 V DC (other models)	100 to 240 V AC 24 V AC 12 to 24 V DC (other models)	100 to 240 V AC 24 V AC 12 to 24 V DC (other models)	100 to 240 V AC/DC 12 to 48 V AC/DC (other models)	100 to 120 V AC, 200 to 220 V AC, 12 V DC, 24 V DC (other models)
Arrangement		Timed-out 2 Form C	(Relay output type) Timed-out 1 Form C (Transistor output type) Timed-out 1 Form A	(Relay output type) Timed-out 1 Form C (Transistor output type) Timed-out 1 Form A	(Relay output type) Timed-out 1 Form C (Transistor output type) Timed-out 1 Form A	T.D. mode: Time delay 2C INST. mode: Time delay 1C and instantaneous 1C (Use MODE switch on front)	Timed-out 2 Form C Timed-out 4 Form C
Time accuracy	Operation time fluctuation	±0.3%	±(0.005% + 50 ms) in case of power on start ±(0.005% + 20 ms) in case of reset or input signal start	±(0.005% + 50 ms) in case of power on start ±(0.005% + 20 ms) in case of reset or input signal start	±(0.005% + 80 ms) in case of power on start ±(0.005% + 20 ms) in case of reset or input signal start	±(0.01% + 0.05 s) in case of power on start ±0.005% ±0.03 s (G type only)	±1%
	Temperature error	±2%					±5%
	Voltage error	±0.5%					±1%
	Setting error	±5%					±10%
Min. power off time		300 ms	500 ms	500 ms	500 ms	100 ms	100 ms
Life (Min. operation)	Mechanical	2 × 10 ⁷	2 × 10 ⁷	2 × 10 ⁷	2 × 10 ⁷	2 × 10 ⁷	10 ⁷
	Electrical	10 ⁵	10 ⁵ 10 ⁷	10 ⁵ 10 ⁷	10 ⁵ 10 ⁷	10 ⁵ 10 ⁷	2 × 10 ⁵
Terminal layouts and Wiring diagrams		Pin type  Screw terminal type 	11-Pin type  Screw terminal type 	 Screw terminal type 	11-Pin type  Screw terminal type 	QM4H-S type  QM4H-G type 	Timed-out 2 Form C type  Timed-out 4 Form C type 
Available standards		UL/CSA, CE, LLOYD	UL/c-UL, CE	UL/c-UL, CE	UL/c-UL, CE	UL/c-UL, CE	UL/c-UL, CE
Page		P. 29	P. 34	P. 34	P. 41	P. 50	P. 57

TIMERS SELECTOR CHART

Operation mode		Power ON-delay Power flicker Power One-shot Power One-cycle	Pulse ON-delay Pulse Flicker Pulse ON-Flicker Signal OFF-delay Pulse One-shot Pulse One-cycle	Power ON-delay	Pulse ON-delay Pulse Flicker Pulse ON-flicker Signal OFF-delay Pulse One-shot Pulse One-cycle (with instantaneous contact)	Power ON-delay
		Output with contact	CR oscillation counting timer		CR oscillation counting timer	CR oscillation counting timer
Major uses		For highly accurate time setting	For time control for short or long time	For time control for short or long time	For self holding circuit	For time ranges selection
Time range	1000h 100h 30h 1h 30m 10m 5m 2m 1m 30s 10s 5s 1s 0.1s 0.01s					
	Each model has various time ranges. See the product lists before ordering.					
Model/Product Name		S1DX Timer	PM5S-A Multi-range analog timer	PM5S-S Multi-range analog timer	PM5S-M Multi-range analog timer	PMH Timer
Features		With a large transparent dial. This timer can be attached both on the DIN rails and panel.	16 time ranges are selectable. 1s to 500h (Max. range) is controlled. 6 operation modes available.	16 time ranges are selectable. 1s to 500h (Max. range) is controlled in one unit.	16 time ranges are selectable. 1s to 500h (Max. range) is controlled in one unit. 6 operation modes (with instantaneous contact) available.	A multitimer is provided with the front operation slide switch by using the special C-MOSIC inside pulse oscillation counting method.
Control output (resistive)	Current	7A 5A 3A	5A	5A	5A	7A
	Voltage	250 V AC	250 V AC	250 V AC	250 V AC	250 V AC
Mounting method						
Mounting parts		Terminal block, cap block, mounting frame, fitting sockets, protective cover	Terminal block, cap, panel cover, rubber gasket, mounting frame	Terminal block, cap, panel cover, rubber gasket, mounting frame	Terminal block, cap, panel cover, rubber gasket, mounting frame	Terminal block, socket, cap, mounting frame, protective cover
Rated operating voltage		100 to 120 V AC, 200 to 220 V AC, 12 V DC, 24 V DC, 48 V DC, 100 to 110 V DC (other models)	24 to 240V AC/DC	24 to 240V AC/DC	24 to 240V AC/DC	100 to 120 V AC, 200 to 240 V AC, 12 V DC, 24 V DC, 48 V DC, 100 to 110 V DC (other models)
Arrangement		Timed-out 2 Form C Timed-out 4 Form C	Timed-out 2 Form C	Timed-out 2 Form C	Timed-out 1 Form C Instantaneous 1 Form C	Timed-out 2 Form C
Time accuracy	Operation time fluctuation	±1%	±0.3%	±0.3%	±0.3%	±0.5%
	Temperature error	±5%	±2%	±2%	±2%	±5%
	Voltage error	±1%	±0.5%	±0.5%	±0.5%	±0.5%
	Setting error	±10%	±10%	±10%	±10%	±10%
Min. power off time		100 ms	100 ms	100 ms	100 ms	100 ms
Life (Min. operation)	Mechanical	10 ⁷	2 × 10 ⁷	2 × 10 ⁷	2 × 10 ⁷	5 × 10 ⁷
	Electrical (resistive)	2 × 10 ⁵	10 ⁵	10 ⁵	10 ⁵	2 × 10 ⁵
Wiring diagrams						
Available standards		UL/CSA, CE, LLOYD	UL/C-UL	UL/C-UL	UL/C-UL	UL/CSA, LLOYD
Page		P. 63	P. 73	P. 73	P. 73	P. 80

TIMERS SELECTOR CHART

Operation mode		Power ON-delay	
Major uses		Motor timer	
Major uses		Suitable for high accurate, long time uses	
Time range			
Each model has various time ranges. See the product lists before ordering.			
Model/Product Name		 MHP Timer	 MHP-M Timer
Features		A motor timer with high accuracy. With a movable point and instantaneous contact (for the MHP-M)	
Control output (resistive)	Current	7A 5A 3A	5A
	Voltage	250 V AC	250 V AC
Mounting method			
Mounting parts		Terminal block, socket, cap, mounting frame, protective cover	
Rated operating voltage		100 V AC, 200 V AC (other models)	
Arrangement		Timed-out 1 Form C	Timed-out 1 Form C Instantaneous 1 Form A
Time accuracy	Operation time fluctuation	±2%	
	Temperature error	—	
	Voltage error	—	
	Setting error	—	
Min. power off time		300 ms	
Life (Min. operation)	Mechanical	10 ⁷	
	Electrical (resistive)	4 × 10 ⁵	
Wiring diagrams			
Available standards		UL/CSA, LLOYD	UL/CSA, LLOYD
Page		P. 82	P. 82

ON-DELAY TIMER BASIC CIRCUIT

(Symbols)	
	Self-resetting switch
	Holding switch
	Relay
	Timer
	Load
	Timer in work
	Relay NO contact
	Relay NC contact
	Timer delay NO contact
	Timer delay NC contact
	Timer instantaneous NO contact
	Timer instantaneous NC contact

1. Delay Operation (Instantaneous input)

When control switch A is pressed, timer T starts immediately and after t-time elapses, load L is turned ON. When B is pressed, timer T is reset and load L is turned OFF.

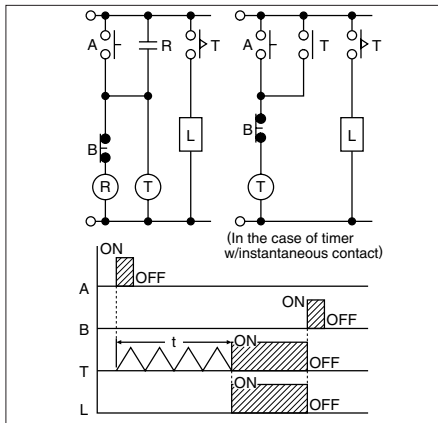

2. Delay Operation (Continuous input)

When switch A is pressed, after t-time elapsed, the timer contact closes and load L is turned ON. When switch A is opened, the timer is reset and the load is turned OFF.

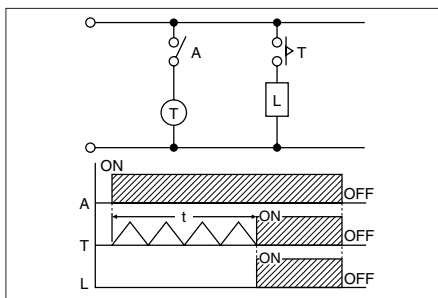

3. Fixed Time Operation (Instantaneous input)

When control switch A is pressed, load L is immediately turned ON, and after t-time elapses, load L is turned OFF.

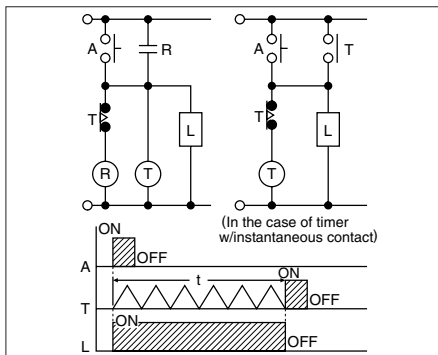

4. Fixed Time Operation (Continuous input)

When switch A is closed, load L is turned ON and after t-time elapses, the load is turned OFF. When switch A is opened, timer T is reset and load L is turned OFF.

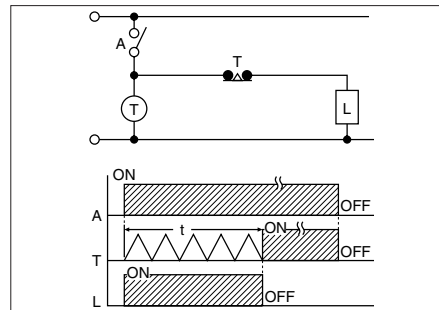

5. Delay Reset Operation

When contact A is reversed, load L is immediately turned ON. When contact A is returned to normal state, load L is turned OFF after t-time elapses. This circuit is used when the power supply is kept ON at all times or used for off-delay-like application. However, it can not be used as off-delay timer at the time of power failure.

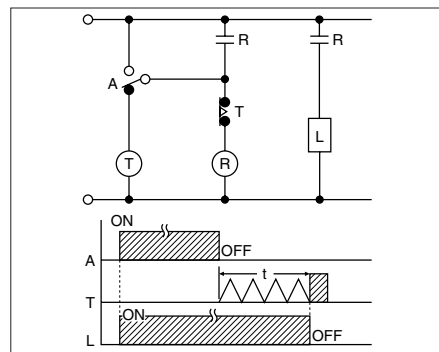

6. Fixed Time Operation after Delay Time is Set (Instantaneous input)

When control switch A is pressed, load L is turned ON after t1-time elapses, and load L is turned OFF after t2-time elapses. This circuit is used for the case of instantaneous input (one pulse).

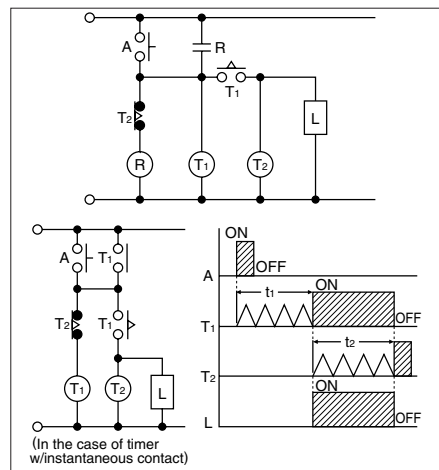

7. Fixed Time Operation after Delay Time is Set (Continuous input)

When switch A is pressed, load L is turned ON after t1-time elapses and load L is turned OFF after t2-time elapses.

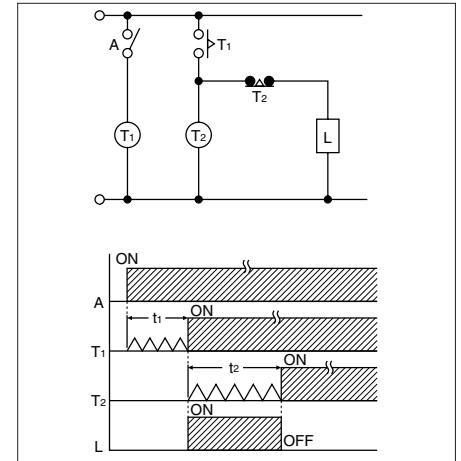

8. Repetitive Operation

When switch A is pressed, load L is turned ON after t1-time elapses and load L is turned OFF after t2-time elapses, and thereafter the t1 and t2 operations are repeated. This repetitive operation stops when switch A is turned OFF.

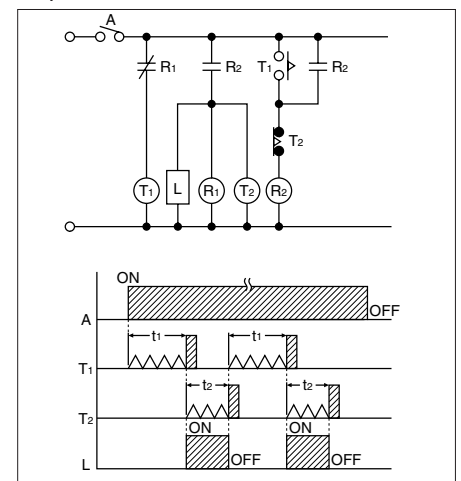

TIMER-RELATED TERMINOLOGY

• What is the timer?

The timer is a relay having such an output (with or without contact) which electrically closes (turns ON) or opens (turns OFF) the circuit after a preset time elapses when electrical or mechanical input is given.

• On-delay Operation (Time delay operation)

The on-delay operation is an operation to give output when preset time expires after a predetermined input is given to the power supply circuit or input circuit. On-delay operation includes power supply on-delay operation and signal on-delay operation.

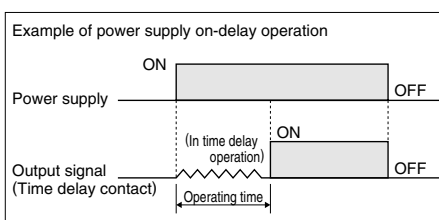

• Off-delay Operation (Time delay resetting)

The off-delay operation is an operation to turn OFF output when preset time expires after a predetermined input is given to the power supply circuit or input circuit, and at the same time output signal is given and predetermined input is turned OFF. Off-delay operation includes power supply off-delay operation and signal off-delay operation.

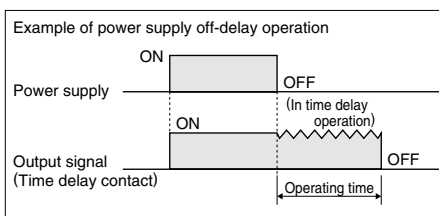

• Flicker Operation

The flicker operation is an operation to repeat output ON/OFF action according to preset ON time and OFF time while a predetermined input is given to the power supply circuit or input circuit. Flicker operation includes OFF-start flicker operation and ON-start flicker operation.

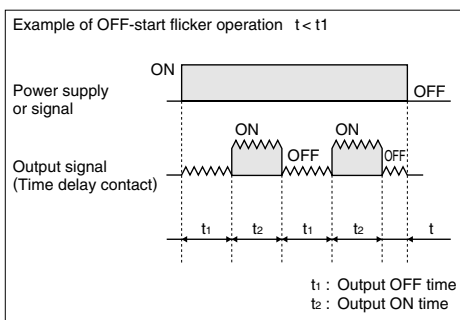

• Star (∧)/Delta (Δ) Operation

This operation controls the time in the star connection used for star-delta starting which is conducted for starting a cage induction motor and the time for switching the star connection over to delta connection.

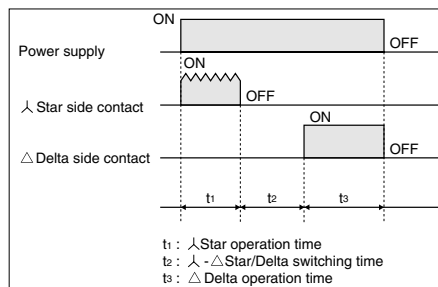

• Preset Time

The preset time is the control time set by setting time-variable timer.

• Operating Time

The operating time means the time which elapses between the addition of predetermined input to the power supply circuit and input circuit and the completion of operation for preset time.

• Hold Time

It means the time which elapses between the completion of operation for preset time and the start of resetting.

• Pause Time

It means the time elapses between the start of operation for preset time and the addition of input required again for the power supply circuit or input circuit. Timer does not perform normal function unless this pause time is set longer than the timer reset time.

• Resetting

It means that the operation returns to the state before starting while the timer is in operation for preset time or after it completes the operation for preset time. Resetting during the operation for preset time is referred to as halfway resetting.

• Reset Time

It means the time elapses between shut-off of input to the power supply circuit or input of reset signal and the completion of resetting.

Timer resetting function shares the reset of contact, reset of mechanical parts such as pointer etc., reset of parts in internal circuit such as capacitor etc., and the value at which all of these parts complete their resetting operation is regarded as reset time. If timer is used for a pause time shorter than specified reset time, the operation time expires earlier than preset, unexpected instantaneous operation takes place or the operation is failed, thus making it impossible

to expect the normal operation.

Therefore, be sure to set the timer pause time longer than the specified reset time.

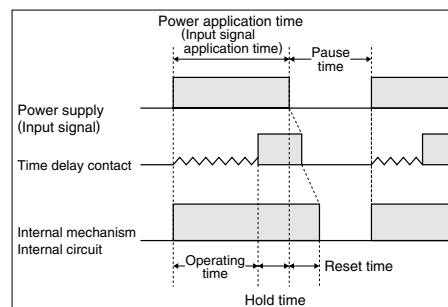

• Minimum Power Application Time

It means the minimum time during which power must be supplied in order to operate timer normally, in the case of power supply off-delay timer.

• Fluctuation of Operating Time

It means the irregularity in operating time caused when timer is set at specified time and the operation is repeated under the same conditions. It is also referred to as repetitive error.

• Voltage Error

It means the difference between the operating time at the rated voltage and that within the allowable voltage range.

• Temperature Error

It means the difference between the operating time at the temperature of $20 \pm 2^\circ\text{C}$ and that within the allowable temperature range.

• Set Error

It means the difference between the set time and the time which actually elapses. It is also referred to as setting error.

The set error of an analog timer is the rate to the full-scale value. If the set error is $\pm 5\%$, it becomes equivalent to an error of maximum ± 5 hours on the assumption that 100 hours is set in the range of 100 hours. The error produced when 10 hours is set is also equivalent to an error of maximum ± 5 hours. As far as the set error is concerned, digital timer is by far exact. Select a digital timer for the case when accuracy is required.

When using an analog type multi-range timer for setting of long time, the setting procedure stated as follows minimizes the error. For example, if you want to set 8 hours in the range of 10 hours, first set the pointer to such a graduation where the actual operating time should become as close to 8 seconds as possible in the range of 10 seconds. Then, reset the range to 10 hours, leaving the pointer set at the graduation as it is.

TIMER-RELATED TERMINOLOGY

• Pause Time Error

It means the difference between the operating time to a fixed pause time and the operating time to a pause time that varies. The pause time characteristics are the main characteristics of CR timer (timer exploiting charge and discharge of capacitor C and resistance R).

If the oscillation count timer (timer which comprises an oscillation circuit composed of CR and quartz and is operated by a counting circuit inside IC or micro-computer which counts the reference signal) is used, the pause time error becomes almost negligible owing to its principles of operation. Accordingly, the description about these characteristics may be omitted for the oscillation count timer.

• Equation for Each Error and Measurement Conditions

The operation time shall be measured, in principle, for retention time of 0.5 second and halt time of 1 second.

The measurement shall be repeated five times except for the initial test. The equation for each error and the measurement conditions are shown in the table below:

Item	Equation	Measurement conditions		
		Set value Ts (Note 1)	Supply voltage	Ambient temperature
(1) Fluctuation in operation time	$\pm \frac{1}{2} \times \frac{T_{max.} - T_{min.}}{TMs} \times 100 (\%)$	Full-scale value	Rated voltage	20±2°C 68±36°F (Note 2)
(2) Voltage error	$\frac{TMx_1 - TM}{TMs} \times 100 (\%)$		Fluctuation range of allowable voltage of power supply (Note 3)	
(3) Temperature error	$\frac{TMx_2 - TM}{TMs} \times 100 (\%)$		Rated voltage	-10 to 50°C +14 to 122°F (Note 4)
(4) Set error	$\frac{TM - Ts}{TMs} \times 100 (\%)$	1/3 or more of full-scale value	Rated voltage	20±2°C 68±36°F (Note 2)
(5) Pause time error	$\frac{TMx_3 - TM}{TMs} \times 100 (\%)$	Full-scale value		

Note 1: For digital timers, the set value Ts shall be optional.

Note 2: If no question arises from evaluation results, 13-35°C is acceptable.

Note 3: The measurement may be performed in other specified voltage ranges.

Note 4: The measurement may be performed in other specified temperature ranges.

TM: Average of measured values for operation time

Ts: Set value

TMs: Full-scale value. For digital timers, any arbitrary scale-value may be used.

Tmax: Maximum of measured values for operation time

Tmin: Minimum of measured values for operation time

TMx₁: Average of operation time at such voltage as maximizes deviation from TM in allowable voltage range.

TMx₂: Average of operation time at such temperature as maximizes deviation from TM in allowable temperature range.

TMx₃: Average of operation time at such pause time (in the range from the specified reset time to 1 hour) as maximizes deviation from TM.

• Functional Vibration Resistance

Means such a vibration as occurs in the range where the contact closed with that vibration during the use of the timer remains closed for the specified time (3 or 1 msec.) minimum.

• Destructive Vibration Resistance

Means such a vibration as occurs in the range where no part is damage with that vibration during the transportation or use of the timer and the operation characteristics are maintained.

• Functional Shock Resistance

Means such a shock as occurs in the range where the contact closed with that shock during the use of the timer remains closed for the specified time (1 ms) minimum.

• Destructive Shock Resistance

Means such a shock as occurs in the range where no part is damaged with that shock during the transportation or use of the timer and the operation characteristics are maintained.

• Mechanical life

Means the durability that is achieved when the control output is performed in the no-load state.

• Electrical life

Means the durability that is achieved when the specified voltage and current loads are individually applied to the control output while being turned ON and OFF. Generally, the life of the timer is represented by the number of times the control output is performed. When a load is connected to the control output, the term of "electrical life" is used. When no load is connected to the control output, the term of "mechanical life" is used. The electrical life is shorter than the mechanical life, and becomes longer as the load decreases. The life of the timer is made longer by connecting a relay or a similar part rather than directly switching a large load with the control output.

• Rated power consumption

Means the power that is consumed when the rated operation voltage is applied to the power circuit.
(Rated power consumption = rated voltage × current consumption)

• Rated control capacity

Means the reference value that is used to determine the performance of the switching part of the load. This value is represented by the combination of voltage and current.

• Contact resistance

Means the combined resistance that consists of the contact resistance between contacts, and the conductor resistance of pins and contact springs.

• Insulation resistance

Means the resistance between a contact or a conductive pin like the pin to which the operation voltage is applied, and a dead pin or a non-conductive metallic part like the time case, the base, or a retaining screw; or the resistance between contacts.

• Withstand voltage

Means the limit value that does not cause breakdown when high voltage is applied for one minute to the same location as measured for insulation resistance. The detectable leak current is normally 10 mA. In special cases, however, it may be 1mA or 3 mA.

• Withstand surge voltage

Means the limit value that shows the durability against momentary abnormal voltage resulting from lightning or switching a conductive load. The surge waveform is represented by the standard impulsive voltage waveform at ±(1.2 × 50) μs or ±(1 × 40) μs.

PRECAUTIONS IN USING THE TIMERS

Cautions for circuits

1. Protective circuit for timer contact

In the circuit that switches an inductive load, a contact failure may occur at a contact point due to surge or inrush current resulting from that switching. Therefore, it is recommended that the following protective circuit be used to protect the contact point.

Circuit	CR circuit (r: resistor c: capacitor)		Diode circuit	Varistor circuit
Application	AC DC	(see note.) Available	Available Available	Not available Available
Features/Notes	<p>If the load is a relay or solenoid, the release time lengthens. Effective when connected to both contacts if the power supply voltage is 24 or 48 V and the voltage across the load is 100 to 200 V.</p> <p>If the load is a timer, leakage current flows through the CR circuit causing faulty operation. Note: If used with AC voltage, be sure the impedance of the load is sufficiently smaller than that of the c and r.</p>		<p>The diode connected in parallel causes the energy stored in the coil to flow to the coil in the form of current and dissipates it as joule heat at the resistance component of the inductive load. This circuit further delays the release time compared to the CR circuit. (2 to 5 times the release time listed in the catalog)</p>	<p>Using the rated voltage characteristics of the varistor, this circuit prevents excessively high voltages from being applied across the contacts. This circuit also slightly delays the release time.</p>
Device Selection	<p>As a guide in selecting r and c, c: 0.5 to 1 μF per 1 A contact current r: 0.5 to 1 Ω per 1 V contact voltage Values vary depending on the properties of the load and variations in timer characteristics. Capacitor c acts to suppress the discharge the moment the contacts open. Resistor r acts to limit the current when the power is turned on the next time. Test to confirm. Use a capacitor with a breakdown voltage of 200 to 300 V. Use AC type capacitors (non-polarized) for AC circuits.</p>		<p>Use a diode with a reverse breakdown voltage at least 10 times the circuit voltage and a forward current at least as large as the load current. In electronic circuits where the circuit voltages reverse breakdown voltage of about 2 to 3 times the power supply voltage.</p>	—

2. Type of Load and Inrush Current

The type of load and its inrush current characteristics, together with the switching frequency are important factors which cause contact welding. Particularly for loads with inrush currents, measure the steady state current and inrush current and use a relay or magnet switch which provides an ample margin of safety. The table below shows the relationship between typical loads and their inrush currents.

Type of load	Inrush current
Resistive load	Steady state current
Solenoid load	10 to 20 times the steady state current
Motor load	5 to 10 times the steady state current
Incandescent lamp load	10 to 15 times the steady state current
Mercury lamp load	1 to 3 times the steady state current
Sodium vapor lamp load	1 to 3 times the steady state current
Capacitive load	20 to 40 times the steady state current
Transformer load	5 to 15 times the steady state current

When you want large load and long life of the timer, do not control the load direct with a timer. When the timer is designed to use a relay or a magnet switch, you can acquire the longer life of the timer.

3. Connection of input

The PM4H and LT4H series use power supply without a transformer (power and input terminals are not insulated). In connecting various kinds of input signals, therefore, use a power transformer in which the primary side is separated from the ungrounded secondary side as shown in Fig. A, for the power supply for a sensor and other input devices so that short-circuiting can be prevented.

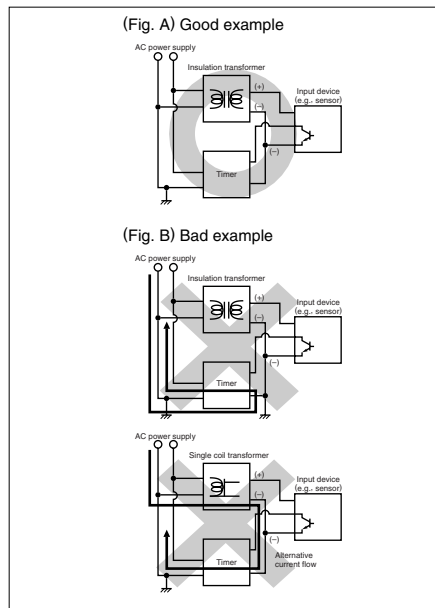

Do not use a single coil transformer (e.g., Sly-Duck). Otherwise, the internal circuit of the timer will be short-circuited as shown in Fig. B resulting in breakdown.

4. Long Continuous Current Flow

Long continuous current flow through the timer (approx. one month or longer) cause generation of heat internally, which degrade the electronic parts. Use the timer in combination with a relay and avoid long continuous current flow through the timer.

(1) When using contact output

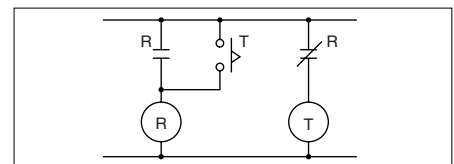

(2) When using non-contact output

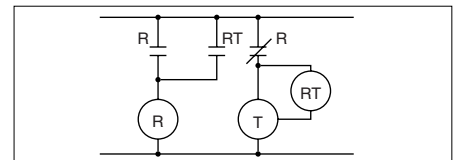

5. Leakage current

1) For connecting and disconnecting operating voltage to the timer, a circuit should be used, which will prevent the flow of leakage current. For example, a circuit for contact protection as shown in Fig. A. will permit leakage current flow through R and C, causing erroneous operation of the timer. Instead, the circuit shown in Fig. B should be used.

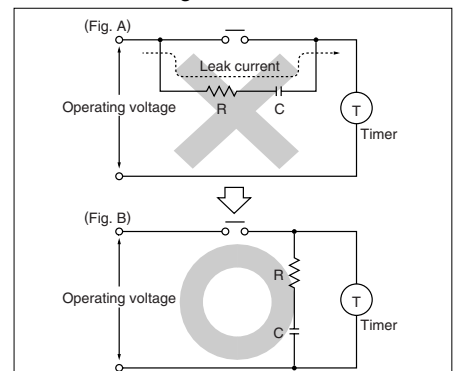

PRECAUTIONS IN USING THE TIMERS

2) If the timer is directly switched with a non-contact element, leak current may flow into the timer and cause it to malfunction.

6. Power off time

If the operation voltage for the timer is turned ON after the limit time operation is completed or before the limit time is reached, the Power off time longer than the timer restoration time must be secured.

7. Suicide circuit

If the timer is restored immediately after the specified time is reached, the circuit must be configured so that the restoration time of the timer can be secured sufficiently.

If the power circuit for the timer is turned OFF with the timer contact, a suicide circuit may be configured (Fig. A). In order to settle the problem with this potential suicide circuit, the circuit must be designed so that the timer is turned OFF after the self-retention circuit is completely released (Fig. B).

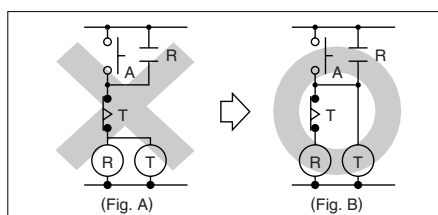

8. Electrical life

The electrical life varies depending on the load type, the switching phase, and the ambient atmosphere. In particular, the following cases require careful attention:

tion:

(1) If an AC load is switched in synchronized phases:

Locking or welding is liable to occur due to contact transposition. Check this with the actual system.

(2) If a load is switched very frequently: If a load which generates arcs when a contact is switched is turned ON and OFF very frequently, nitrogen and oxygen in air are combined due to arc energy and then HNO_3 is produced. This may corrode metallic materials.

The effective countermeasures include:

1. Using an arc-extinguishing circuit;
2. Decreasing the switching frequency; and
3. Decreasing the humidity in the ambient atmosphere.

Cautions for use (common for all models)

1. Pin connections

Correctly connect the pins while seeing the terminal layout/wiring diagram. In particular, the DC type, which has polarities, does not operate with the polarities connected reverse. Any incorrect connection can cause abnormal heating or ignition.

2. Connection to operation power supply

1) Supply voltage must be applied at a time through a switch, a relay, and other parts. If the voltage is applied gradually, the specified time may be reached regardless of its value or the power supply may not be reset.

2) The operation voltage for the DC type must be at the specified ripple percentage or less. The average voltage must fall within the allowable operation voltage range.

Rectification type	Ripple percentage
Single-phase, full-wave	Approx. 48%
Three-phase, full-wave	Approx. 4%
Three-phase, half-wave	Approx. 17%

Note: Refer to the ripple percentage of each timer.

3) Make sure that no induced voltage and residual voltage are applied between the power pins on the timer after the power switch is turned OFF.

(If the power line is wired in parallel with the high-voltage and motor lines, induced voltage may be produced between the power pins.)

3. Control output

1) The load for the control output must be used within the load capacity specified in the rated control capacity. If it is used exceeding the rated value, the life is greatly shortened.

2) The following connection might result in short circuit between the heteropolar contacts in the timer.

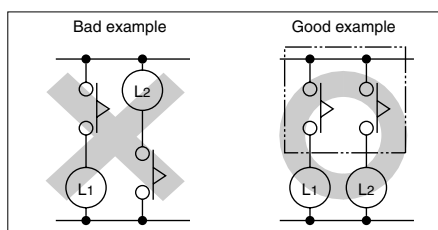

4. Installing the timer

1) To install the timer, use the dedicated pin bracket or socket (cap). Avoid connecting the pins on the timer by directly soldering them.

2) In order to maintain the characteristics, do not remove the timer cover (case).

5. Superimposed surge of power supply

For the superimposed surge of power supply, the standard waveform ($\pm 1.2 \times 50\mu\text{s}$ or $\pm 1 \times 40\mu\text{s}$) is taken as the standard value for surge-proof voltage. (The positive and negative voltages are applied each three or five times between the power pins.)

For the standard values for the PM4H, LT4H and S1DX type timers, see the respective items in "Cautions for use."

• Single-pole, full-wave voltage for surge waveform [$\pm(1.2 \times 50) \mu\text{s}$]

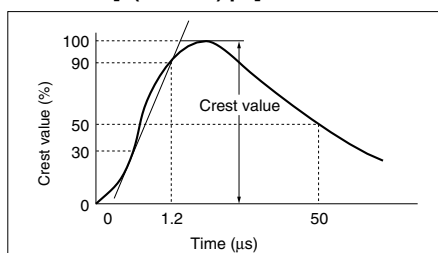

• Single-pole, full-wave voltage for surge waveform [$\pm(1 \times 40) \mu\text{s}$]

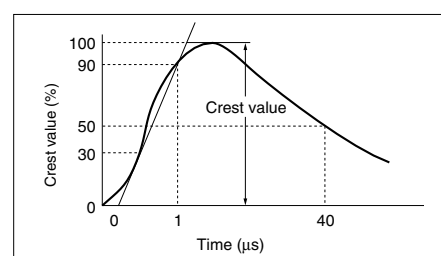

• PMH [$\pm(1 \times 40) \mu\text{s}$]

Voltage type	Surge voltage
AC type (Except for 24V AC)	4,000V
12V DC, 24V DC, 24V AC	500V
48V DC	1,000V
100 to 110V DC	2,000V

If external surge occurs exceeding the specified value, the internal circuit may break down. In this case, use a surge absorption element. The typical surge absorption elements include a varistor, a capacitor, and a diode. If a surge absorption element is used, use an oscilloscope to see whether or not the foreign surge exceeding the specified value appears.

6. Changing the set time

Do not change the set time when the limit time operation is in progress. However, this is possible only with the motor-driven type timer if the set time is shorter than the remaining time. For changing the set time on the digital timer (LT4H series), see the relevant item in "Cautions for use."

PRECAUTIONS IN USING THE TIMERS

7. Operating environment

1) Use the timer within the ambient temperature range from -10°C to $+50^{\circ}\text{C}$ ($+14^{\circ}\text{F}$ to $+122^{\circ}\text{F}$ ($+55^{\circ}\text{C}$ $+131^{\circ}\text{F}$ for the LT4H series) and at ambient humidity of 85% RH maximum.

2) Avoid using the timer in a location where inflammable or corrosive gas is generated, the timer is exposed to much dust and other foreign matter water or oil is splashed on the timer or vibrations or shocks are given to the timer.

3) The timer cover (case), the knobs, and the dials are made of polycarbonated resin. Therefore, prevent the timer from being exposed to organic solvents such as methyl alcohol, benzene, and thinner, strong acid substances such as

caustic soda, and ammonia and avoid using the timer in atmosphere containing any of those substances.

4) If the timer is used where noises are emitted frequently, separate the input signal elements (such as a sensor), the wiring for the input signal line, and the timer as far as possible from the noise source and the high power line containing noises.

8. Checking the actual load

In order to increase the reliability in the actual use, check the quality of the timer in the actual usage.

9. Others











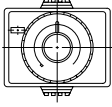



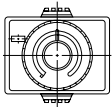













1) If the timer is used exceeding the ratings (operation voltage and control capacity), the contact life, or any other

specified limit, abnormal heat, smoke, or ignition may occur.





















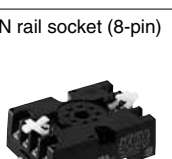
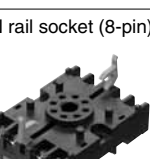



2) If any malfunction of the timer is likely to affect human life and properties, give allowance to the rated values and performance values. In addition, take appropriate safety measures such as a duplex circuit from the viewpoint of product liabilities.

DISCONTINUED MODELS AND RECOMMENDED SUBSTITUTES

















Timers















Discontinued models	Recommended substitutes	Attachment	Discontinued models	Recommended substitutes	Attachment
MHP-NS (Exposed type Square plug-in/ horizontal type) 	MHP-N (Exposed type Round plug-in/ vertical type) 	Terminal base AT8-RFD should be used.	CHP-NF (Exposed type Round plug-in/ vertical type) 	PM4H-F 	Attachment frame AT7821 should be used. * External dimensions, however, differ. In addition, the reset method changes from voltage input to non-voltage input.
MHP-NS-	MHP-N-		CHP-NF	PM4HF-	
MHP-M (Exposed type Round plug-in/ horizontal type) 	MHP-NM (Exposed type Round plug-in/ vertical type) 	Terminal base AT8-RFD should be used.	CHP-SD 	PM4H-SD 	With exposed attachment, terminal base ATC180041 should be used. * External dimensions and contact capacity, however, differ. In addition, with the PM4H-SD: 1) (1) to (8) have no internal connection, and 2) the input (star) changes to 1a.
MHP-M-	MHP-NM-		CHP-SD-	PM4HSD-	
MHP-YC (Embedded type With attachment frame) 	MHP-N (Exposed type Without attachment frame) 	Attachment frame AT7821 should be used.	PM48A 	PM4H-A 	With exposed attachment, terminal base ATC180041 should be used.
MHP-YC-	MHP-N-		PM48A-	PM4HA-	
MHP-YM (Embedded type With attachment frame) 	MHP-NM (Exposed type Without attachment frame) 	Attachment frame AT7831 should be used.	PM48 	PM4H-S 	With exposed attachment, terminal base ATC180031 should be used.
MHP-YM-	MHP-NM-		PM48	PM4HS-	
CHP-N (Exposed type with attachment frame type) 	PM4H-S PMH 	The external dimension and contact capacity are different.	PM48M 	PM4H-M 	With exposed attachment, terminal base ATC180031 for F8 type and F8R type ATC180041 for F11R type.
CHP-N-	PM4HS- PMH-		PM48M-	PM4HM-	
CHP-N (Exposed type without attachment frame type) 	PM4H-S PMH 	The external dimension and contact capacity are different.	PM48F 	PM4H-F 	With exposed attachment, terminal base ATC180031 for F8 type and F8R type ATC180041 for F11R type.
CHP-N-	PM4HS- PMH-		PM48F-	PM4HF-	
CHP-NF (Exposed type without attachment frame type) 	PM4H-F 	* External dimensions, however, differ. In addition, the reset method changes from voltage input to non-voltage input.	PM48SD 	PM4H-SD 	With exposed attachment, terminal base ATC180031 should be used.
CHP-NF-	PM4HF-		PM48SD	PM4HSD	

Timers

Discontinued models	Recommended substitutes	Attachment	Discontinued models	Recommended substitutes	Attachment
PM48W 	PM4H-W 	With exposed attachment, terminal base ATC180031 should be used.	LT48 (8-pin) 	LT4H (8-pin) 	
PM48W PMH-M 	PM4H-W- PM4H-M/PM4S 	The external dimension and contact capacity are different.	LT48 LT48W (8-pin) 	LT4H LT4H-L LT4H-W (8-pin) 	
PMH-M- CDX Time relay 	PM4HM-/PM4S- S1DXM-A Timer/ S1DX Timer 		LT48W LT48W (8-pin) 	LT4HW LT4H-W (8-pin) 	
CDX PDX Timer 	S1DXM-/S1DX- S1DXM-A Timer/ S1DX Timer 		DIN rail socket (8-pin) 	DIN rail socket (8-pin) 	
PDX VHP digital high-power timer 	S1DXM-/S1DX- S1DXM-A Timer/ S1DX Timer 		ATC18003 DIN rail socket (11-pin) 	ATC180031 DIN rail socket (11-pin) 	
VHP QM48S (8-pin) 	QM4H digital timer QM4H (8-pin) 	The size is different. Compact size ↓ DIN48	ATC18004 DIN rail socket (11-pin) 	ATC180041 DIN rail socket (11-pin) 	
QM48S QM72S (Screw terminal) 	QM4H (8-pin) 	The size is different. □72 ↓ □48			
QM72S	QM4H				

In some cases, the specifications of the recommended substitutes are not exactly the same as those of the discontinued model. Please confirm the specifications before using the recommended substitutes.

Counters		
Discontinued models	Recommended substitutes	Attachment
MC electromagnetic counters  MC6	LC4H  LC4H LC4H-L	The size and attachment method are different. The input method is different. (Voltage input → non-voltage input)
LC48 (Relay type: 8-pin Tr type: 11-pin)  LC48	LC4H (Relay type: 8-pin Tr type: 11-pin)  LC4H LC4H-L	
LC48W (11-pin)  LC48W	LC4H-W (11-pin)  LC4H-W	
EM48S (8-pin)  EM48S	LC4H (8-pin)  LC4H LC4H-L	
EM72S (Screw terminal)  EM72S	LC4H (Screw terminal)  LC4H LC4H-L	The size is different. <input type="checkbox"/> 72  <input type="checkbox"/> 48
LC24 Panel-mounting type  <ul style="list-style-type: none"> • One-touch installation type LC24 	LC2H Panel-mounting type   <ul style="list-style-type: none"> • One-touch installation type • Installation frame type LC2H 	The both one-touch installation type and installation frame type are available.
LC24 PC board mounting type  LC24	LC2H PC board mounting type  LC2H	

Hour meters		
Discontinued models	Recommended substitutes	Attachment
 TH11* TH12*	 TH141S TH142S	Body Round type (attachment hole ϕ 45)  Square type (attachment hole \square 45)
 TH21* TH22*	 TH241S TH242S	Body Square type (attachment hole \square 47)  Square type (attachment hole \square 45)
TH30  TH30	LT4H (~999.9 h)  LT4H LT4H-W (~9999 h)  LT4HW	The size and attachment method are different. The input method is different. (Voltage input → non-voltage input)
LH24 Panel-mounting type  <ul style="list-style-type: none"> • One-touch installation type LH24 	LH2H Panel-mounting type   <ul style="list-style-type: none"> • One-touch installation type • Installation frame type LH2H 	The both one-touch installation type and installation frame type are available.
LH24 PC board mounting type  LH24	LH2H PC board mounting type  LH2H	

In some cases, the specifications of the recommended substitutes are not exactly the same as those of the discontinued model. Please confirm the specifications before using the recommended substitutes.

FOREIGN SPECIFICATIONS OVERVIEW

1. International Standards

IEC standard

International Electrotechnical Commission

By promoting international cooperation toward all problems and related issues regarding standardization in the electrical and electronic technology fields, the IEC, a non-governmental organization, was started in October, 1908, for the purpose of realizing mutual understanding on an international level. To this end, the IEC standard was enacted for the purpose of promoting international standardization.

2. North America

UL (Underwriters Laboratories Inc.)

This is a non-profit testing organization formed in 1894 by a coalition of U.S. fire insurance firms, which tests and approves industrial products (finished products). When electrical products are marketed in the U.S., UL approval is mandated in many states, by state law and city ordinances. In order to obtain UL approval, the principal parts contained in industrial products must also be UL-approved parts.

UL approval is divided into two general types. One is called "listing" (Fig. 1), and applies to industrial products (finished products). Under this type of approval, products must be approved unconditionally. The other type is called "recognition" (Fig. 2), and is a conditional approval which applies to parts and materials.

CSA (Canadian Standards Association)

This was established in 1919 as a non-profit, non-governmental organization aimed at promoting standards. It sets standards for industrial products, parts, and materials, and has the authority to judge electrical products to determine whether they conform to those standards. The CSA is the ultimate authority in the eyes of both the government and the people in terms of credibility and respect. Almost all states and provinces in Canada require CSA approval by law, in order to sell electrical products. As a result, electrical products exported from Japan to Canada are not approved under Canadian laws unless they have received CSA approval and display the CSA mark. Approval is called "certification", and products and parts which have been approved are called "certified equipment", and display the mark shown in Fig. 3. The mark shown in Fig. 4 is called the "Component Acceptance" mark, and indicates conditional approval which is applicable to parts. The C-UL mark shown in Fig. 5 (finished products) and Fig. 6 (parts) indicates that the product has been tested and approved in UL laboratories, based on UL and CSA standards, through mutual approval activities.

LISTING MARK



Fig. 1

RECOGNITION MARK



Fig. 2

Certification



Fig. 3

Component Acceptance



Fig. 4



Fig. 5



Fig. 6

3. Europe

EN standard

European Standards/Norme Europeennee (France)/Europaishe Norm (Germany)

Abbreviation for European Standards. A unified standard enacted by CEN/CENELEC (European Standards Committee/European Electrical Standards Committee). EU and EFTA member nations employ the content of the EN standards into their own national standards and are obligated to abolish those national standards that do not agree with the EN standards.

(1) Germany



VDE (Verband Deutscher Elektrotechniker)

The VDE laboratory was established mainly by the German Electric Technology Alliance, which was formed in 1893. It carries out safety experiments and passes approval for electrical devices and parts. Although VDE certification is not enforced under German law, punishment is severe should electrical shock or fire occur; therefore, it is, in fact, like an enforcement.



TÜV (Technischer Überwachungs-Verein)

TÜV is a civilian, non-profit, independent organization that has its roots in the German Boiler Surveillance Association, which was started in 1875 for the purpose of preventing boiler accidents. A major characteristic of TÜV is that it exists as a combination of 14 independent organizations (TÜV Rheinland, TÜV Bayern, etc.) throughout Germany. TÜV carries out inspection on a wide variety of industrial devices and equipment, and has been entrusted to handle electrical products, as well, by the government. TÜV inspection and certification is based mainly on the VDE standard. TÜV certification can be obtained from any of the 14 TÜVs throughout Germany and has the same effectiveness as obtaining VDE certification.

4. Shipping Standards

(1) Lloyd's Register of Shipping



Standards from the Lloyd's Register shipping association based in England. These standards are safety standards for environmental testing of the temperature and vibration tolerances of electrical components used for UMS (unmanned machine rooms in marine vessels) applications. These standards have become international standards for control equipment in all marine vessel applications. No particular action is taken to display the conformation to these standards on the products.

5. Pilot Duty

One of the specifications in the “UL508 Industrial Control Equipment” regulations at UL (Underwriters Laboratories Inc.), has to do with the grade of contact control capacity by NEMA (National Electrical Manufacturers Association) standards. By obtaining both UL and CSA approval for this grade, the product becomes authorized publicly.

Pilot Duty A300

AC applied voltage [V]	Electrification current [A]	Input power [A]	Breaker power [A]	[VA]	
				During input	During breaker
120	10	60	6	7,200	720
240		30	3	7,200	720

Pilot Duty B300

AC applied voltage [V]	Electrification current [A]	Input power [A]	Breaker power [A]	[VA]	
				During input	During breaker
120	5	30	3	3,600	360
240		15	1.5	3,600	360

Pilot Duty C300

AC applied voltage [V]	Electrification current [A]	Input power [A]	Breaker power [A]	[VA]	
				During input	During breaker
120	2.5	15	1.5	1,800	180
240		7.5	0.7	1,800	180

FOREIGN SPECIFICATIONS

TIMER

Products Name	Recognized by UL Standards		Certified by CSA Standards		Lloyd's Register Standards		Remarks	
	File No.	Recognized rating	File No.	Certified rating	File No.	Certified rating		
PM4S	E43149	5A250VAC PILOT DUTY C300	E43149 (C-UL)	5A250VAC PILOT DUTY C300	—	—		
PM4H-A PM4H-S PM4H-M PM4H-SD PM4H-W	E122222	5A250VAC PILOT DUTY C300	LR39291	5A250VAC PILOT DUTY C300	98/10004	5A 250V AC (resistive)		
PM4H-F	E122222	3A250VAC PILOT DUTY C300	LR39291	3A250VAC PILOT DUTY C300	98/10004	3A 250V AC (resistive)		
LT4H LT4H-L LT4H-W	E122222	5A250VAC PILOT DUTY C300 100mA30VDC	E122222 (C-UL)	5A250VAC PILOT DUTY C300 100mA30VDC	—	—		
QM4H	E43149	5A250VAC PILOT DUTY C300	E43149 (C-UL)	5A250VAC PILOT DUTY C300	—	—		
PMH	E59504	7A1/6HP125VAC 7A1/6HP250VAC 3A30VDC PILOT DUTY C300	LR39291	7A1/6HP125VAC 7A1/6HP250VAC 3A30VDC PILOT DUTY C300	88/10123	125V3.5A (COS $\phi \approx 0.4$) 250V2A (COS $\phi \approx 0.4$) 250V7A (COS $\phi \approx 1.0$)	"The standard models conform to the UL/CSA standard. (To place an order, you do not need to specify the tailing character [9] of each item number.)" The standard models conform to the LLOYD standard.	
MHP MHP-M	E59504	5A250VAC	LR39291	5A250VAC	88/10123	250V5A (COS $\phi \approx 1.0$)	"The standard models conform to the UL/CSA standard. (To place an order, you do not need to specify the tailing character [9] of each item number.)"	
S1DXM-A/M (Relay output)	2C	E122222	7A125VAC 6A250VAC 1/6HP125, 250VAC PILOT DUTY C300	LR39291	7A125VAC 6A250VAC 1/6HP125, 250VAC PILOT DUTY C300	98/10004	7A 250V AC (resistive)	
	4C	E122222	5A250VAC 1/10HP125, 250VAC PILOT DUTY C300	LR39291	5A250VAC 1/10HP125, 250VAC PILOT DUTY C300	98/10004	5A 250V AC (resistive)	
S1DX (Relay output)	2C	E122222	7A125VAC 6A250VAC 1/6HP125, 250VAC PILOT DUTY C300	LR39291	7A125VAC 6A250VAC 1/6HP125, 250VAC PILOT DUTY C300	98/10004	7A 250V AC (resistive)	
	4C	E122222	5A250VAC 1/10HP125, 250VAC PILOT DUTY C300	LR39291	5A250VAC 1/10HP125, 250VAC PILOT DUTY C300	98/10004	5A 250V AC (resistive)	
PM5S-A PM5S-S PM5S-M	E59504 (C-UL)	5A250VAC PILOT DUTY C300	E59504 (C-UL)	5A250VAC PILOT DUTY C300	—	—		

Accessories

Products Name	Recognized by UL Standards		Certified by CSA Standards		Lloyd's Register Standards		Remarks
	File No.	Recognized rating	File No.	Certified rating	File No.	Certified rating	
Common mounting tracks for timers	E59504	10A250VAC AT8-RFD (AT78039) 7A250VAC AT8-DF8L (ATA48211) 8P cap was an approved as an option. AD8-RC (AD8013)	LR39291	10A250VAC AT8-RFD (AT78039) 7A250VAC AT8-DF8L (ATA48211) 8P cap was an approved as an option. AD8-RC (AD8013)	—	—	
	E148103	AT8-DF8K (ATC180031) AT8-DF11K (ATC180041) AT8-R8K (AT78041) AT8-R11K (AT78051)	E148103 (C-UL)	AT8-DF8K (ATC180031) AT8-DF11K (ATC180041) AT8-R8K (AT78041) AT8-R11K (AT78051)	—	—	

FOREIGN SPECIFICATIONS

Counters

Product name	UL recognized		CSA certified		Remarks
	File No.	Approved ratings	File No.	Approved ratings	
LC4H LC4H-L LC4H-S	E122222	5A250V AC PILOT DUTY C300 100mA 30V DC	E122222 (C-UL)	5A250V AC PILOT DUTY C300 100mA 30V DC	
LC4H-W	E122222	3A250V AC PILOT DUTY C300 100mA 30V DC	E122222 (C-UL)	3A250V AC PILOT DUTY C300 100mA 30V DC	
LC2H	E122222	24-240 V AC/DC 4.5-30 V DC 3 V DC	E122222 (C-UL)	24-240 V AC/DC 4.5-30 V DC 3 V DC	
LC2H preset	E122222	24-240 V AC/DC 4.5-30 V DC 3 V DC	E122222 (C-UL)	24-240 V AC/DC 4.5-30 V DC 3 V DC	

Hour Meters

Product name	UL recognized		CSA certified		Remarks
	File No.	Approved ratings	File No.	Approved ratings	
TH13 · TH23 series	E42876	115-120, 220, 240V AC	LR39291	115-120, 220, 240V AC	• For UL-recognized and CSA-certified products, specify "U" at the end of the part No.
TH14 · TH24 series	E42876	12, 24, 48, 100, 110, 115-120, 200, 220, 240V AC	LR39291	12, 24, 48, 100, 110, 115-120, 200, 220, 240V AC	• Only black panel-mounting type UL-recognized and CSA-certified. • For UL-recognized and CSA-certified products, specify "U" at the end of the product code. • Panel-mounting silver type not UL-recognized nor CSA-certified.
TH63 · 64 series	E42876	12, 24, 48, 100, 110, 115-120, 200, 220, 240V AC	LR39291	12, 24, 48, 100, 110, 115-120, 200, 220, 240V AC	• Standard products are UL-recognized and CSA-certified.
LH2H	E122222	24-240 V AC/DC 4.5-30 V DC 3 V DC	E122222 (C-UL)	24-240 V AC/DC 4.5-30 V DC 3 V DC	• Standard products are UL-recognized and CSA-certified.
LH2H preset	E122222	24-240 V AC/DC 4.5-30 V DC 3 V DC	E122222 (C-UL)	24-240 V AC/DC 4.5-30 V DC 3 V DC	• Standard products are UL-recognized and CSA-certified.
TH8 series	E42876	12 V DC 24 V DC	E42876 (C-UL)	12 V DC 24 V DC	• Standard products are UL-recognized and CSA-certified.

Accessories

Product name	UL-recognized		CSA certified		Remarks
	File No.	Rating	File No.	Rating	
Common counter fixtures	E59504	10A250V AC AT8-RFD (AT78039) 7A250V AC AT8-DF8L (ATA48211) 8P cap CSA-certified as option. AD8-RC (AD8013)	LR26550	10A250V AC AT8-RFD (AT78039) 7A250V AC AT8-DF8L (ATA48211) 8P cap UL-listed as option. AD8-RC(AD8013)	
	E148103	AT8-DF8K (ATC180031) AT8-DF11K (ATC180041) AT8-R8K (AT78041) AT8- R11K (AT78051)	E148103 (C-UL)	AT8-DF8K (ATC180031) AT8-DF11K (ATC180041) AT8-R8K (AT78041) AT8- R11K (AT78051)	

CE MARKINGS OVERVIEW

Counter, Hour Meter conforming to EN/IEC standards

The Timer, Counter, Hour Meter shown below conform to both EN and IEC standards, and may display the CE markings.

Product classification	Product name	EMC directives	Low-voltage directives
Timers	LT4H	EN 61000-6-4/EN 61000-6-2	EN 61812-1
	LT4H-L	EN 61000-6-4/EN 61000-6-2	EN 61812-1
	LT4H-W	EN 61000-6-4/EN 61000-6-2	EN 61812-1
	PM4H	EN 61000-6-4/EN 61000-6-2	EN 61812-1
	S1DX	EN 61000-6-4/EN 61000-6-2	EN 61812-1
	S1DXM-A/M	EN 61000-6-4/EN 61000-6-2	EN 61812-1
	PM4S	EN 61000-6-4/EN 61000-6-2	EN 61812-1
	PM5S	EN 61000-6-4/EN 61000-6-2	EN 61812-1
	QM4H	EN 61000-6-4/EN 61000-6-2	EN 61010-1
Time Switch	A-TB72	EN 61000-6-4/EN 61000-6-2	EN 61812-1
	A-TB72Q	EN 61000-6-4/EN 61000-6-2	EN 61812-1
Counters	LC4H	EN 61000-6-4/EN 61000-6-2	EN 61812-1
	LC4H-L	EN 61000-6-4/EN 61000-6-2	EN 61812-1
	LC4H-S	EN 61000-6-4/EN 61000-6-2	EN 61812-1
	LC4H-W	EN 61000-6-4/EN 61000-6-2	EN 61812-1
	LC2H	EN 61000-6-4/EN 61000-6-2	EN 61010-1
	LC2H preset	EN 61000-6-4/EN 61000-6-2	—
Hour Meters	TH13	EN 61000-6-4/EN 61000-6-2	EN 61010-1
	TH23	EN 61000-6-4/EN 61000-6-2	EN 61010-1
	TH14	EN 61000-6-4/EN 61000-6-2	EN 61010-1
	TH24	EN 61000-6-4/EN 61000-6-2	EN 61010-1
	TH40	EN 61000-6-4/EN 61000-6-2	EN 61010-1
	TH50	EN 61000-6-4/EN 61000-6-2	EN 61010-1
	TH63	EN 61000-6-4/EN 61000-6-2	EN 61010-1
	TH64	EN 61000-6-4/EN 61000-6-2	EN 61010-1
	LH2H	EN 61000-6-4/EN 61000-6-2	EN 61010-1
	LH2H preset	EN 61000-6-4/EN 61000-6-2	—
	TH8	EN 61000-6-4/EN 61000-6-2	—

What are EN standards?

An abbreviation of Norme Europeenne (in French), and called European Standards in English. Approval is by vote among the CEN/CENELEC member countries, and is a unified standards limited to EU member countries, but the contents conform to the international ISO/IEC standards.

If the relevant EN standard does not exist, it is necessary to obtain approval based on the relevant IEC standard or, if the relevant IEC standard does not exist, the relevant standard from each country, such as VDE, BS, SEMKO, and so forth.

CE markings and EC directives

The world's largest single market, the European Community (EC) was born on 1 January 1993 (changing its name to EU in November 1993. It is now always expressed as EU, apart from EC directives.) EU member country products have always had their quality and safety guaranteed according to the individual standards of each member country. However, the standards of each country being different prevented the free flow of goods within the EU. For this reason, in order to eliminate non-tariff barriers due to these standards, and to maximize the merits of EU unification, the EC directives were issued concomitant to the birth of the EU.

The EN standards were established as universal EU standards in order to facilitate EU directives. These standards were merged with the international IEC standards and henceforth reflect the standards in all countries. Also, the CE markings show that products conform to EC directives, and guarantee the free flow of products within the EC.

Appropriate EC directives for control equipment products

The main EC directives that are to do with machinery and electrical equipment are the machinery directive, the EMC directive, the low voltage directive, and the telecom directive. Although these directives have already been issued, the date of their enactment is different for each one. The machinery directive was 1 January 1995. The EMC directive was 1 January 1996, and the low voltage directive was enacted from 1 January 1997. The telecom directive was established by the separate CTR (Common Technology References.)