

Buffering: Electrolytic caps. instead of accumulators

SLV20.200

- Buffering for 24V loads
- Minimum hold-up time: 0.2s/20A (max. buffer time depends on load)
- Fit for industrial use: Energy storage in electrolytic caps., no accumulators
- Clear status indication by Status LED and signalling terminals



PULS

CB
Scheme
IEC60950

UL
US
UL508 LISTED
IND. CONT. EQ.
18 WM, 60°C

UL
US
UL60950 E137005
CUL/CSA-C22.2
No 60950

CE
EMC and
Low Volt.
Directive

Short description

The buffer unit is a supplementary device for regulated DC 24V power supplies. It buffers load currents during typical mains faults and switching events or load peaks.

Working principle

In times when the power supply provides sufficient voltage, the buffer unit stores energy in integrated electrolytic capacitors. In case of a mains voltage fault, this energy is released again in a regulated process.

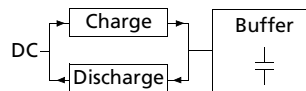

Bridges mains faults without interruption

Statistics show that 80 percent of all mains faults last less than 0.2s. These mains faults are completely bridged by the buffer unit and will have no influence on the DC power (startup-delay of power supply used might be taken under consideration. This increases the reliability of the system as a whole.

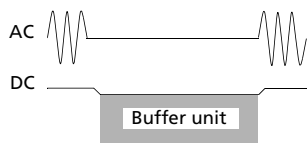

Short Overview - Technical Data

Rated voltage	DC 24V
Voltage range	DC 24...28.8V
Buffered voltage	selectable by front jumper setting Vin -1V: 23 - 27.8V (variable threshold) 22.5V fixed: 22.5V (fixed threshold)
Reversed power immunity	max. +35V
Protection against polarity reversal	max. -35V
Charging current	<600mA
Buffering current	0...20A
Current limitation (Buffer operation)	>20A
Charging time	18...27s (primary charge)
Hold-up time	see diagramm (page 2)
• minimum	0,2s (22,5V/20A) or 28s (22,5V/100mA)
• typical	0,31s (22,5V/20A) or 43s (22,5V/100mA)

Order information

Order number
SLV20.200
XF-1x4s/270-60
SLZ11
SLZ02

Extended hold-up time

Once the main power fails or is switched off, the buffer unit will continue to provide the load current for a defined period of time. Process data can be saved and processes can be terminated before the DC power switches off. Controlled restarts are subsequently possible.

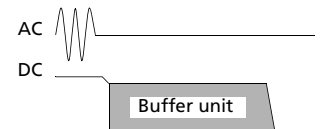

Easy to handle, expandable and maintenance-free

The buffer unit does not require any control wiring. It can be added parallel to the load circuit at any given point. Any given number of buffer units can be switched parallel to increase the output capacity or the hold-up time. The dual terminals allow for easy wiring. In addition, there is a housing connection.

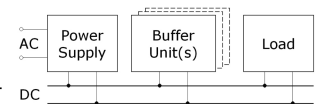

Short Overview - Technical Data

Idling input current	typ. 80mA
Power dissipation	typ. 1.9W
Degree of protection	IP20 (EN 60529)
Dimensions (W x H x D)	64mm x 124mm x 102mm (without DIN rail)
Weight	740g

Safety

Terminal voltage	SELV, IEC/EN 60950
Classification	PELV (IEC364-4-41) PELV (EN50178) PELV (EN 60204)
Isolation resistance	5MΩ (terminal→housing)
Degree of protection	IP20 (EN 60529)
Penetration protection	> 3.5 x 3.5 mm
Internal fusing	none
Galvanic isolation to signal path	500V

Technical Data

Buffer Charging

Charging delay time	typ. 4s
Charging current	0.4...0.6A
Charging time	18...27s (primary charge / cold start)

Buffer Operation

Rated output current	20A
Current limitation	>20A
Hold-up time	see diagramm (page 2)
• minimum	0,2s (22,5V/20A) or 28s (22,5V/100mA)
• typical	0,31s (22,5V/20A) or 43s (22,5V/100mA)

To increase buffer current and/or extend hold-up time any given number of buffer unit can be switched parallel (max. load per terminal = 30A)

Activation threshold

"22.5V fixed"	Buffering starts if terminal voltage <22.5V, voltage is kept at 22.5V.
"Vin -1V"	Buffering starts if terminal voltage decreases by more than 1V, faster than typ. 0.54V/s. Voltage is kept at that level. Buffering ends when voltage increases once more by 1V.
Noise (spikes)	<200mV _{pp} (20MHz bandw., 50Ω-measurement, buffer operation only)
Over voltage protection	limited to max. ±35V
Operation indicator	Green LED (see below table 'Operating modes')

Environmental Data

Temperature	
• Storage/Transport	-25°C...+85°C
• Operation	-10°C...+70°C (measured at 25mm below the unit)
• Derating	not necessary
• Cooling	natural convection
Humidity	5...95% (condensation not permissible)
Vibration	
• Sinus	2 – 17.8Hz: ±1.6mm 17.8Hz – 500Hz 2g (IEC 60068-2-6)
• Random	2...500Hz 0.5m ² (a ³) (IEC 60068-2-64)
Shock	15g/6ms and 10g/11ms (IEC 60068-2-27)
Degree of pollution	2 (EN 50178)
Installation level	2.000m above sea level

Reliability

MTBF	480.000h t.b.c. (unit on stand-by, T _{amb} = +40°C)
Life time	>42.000h calculated life expectancy (based on T _{amb} = +40°C)

Note: t.b.c. = to be calculated (data will follow)

Operating modes

	Current	Time	Status LED	Output 'Active'	Output 'Ready'	Bulk capacitor array
Buffer charging	400...600mA	18-27s	flashes 1.25Hz	blocking	blocking	charging
Stand-by	80mA	J.	steady light	blocking	low ohmic	fully charged
Buffer operation	0...20A	see diagramm hold-up time	flashes 10Hz	low ohmic	blocking	discharging
Inhibit mode	15mA	J.	off	blocking	blocking	discharged
Unit not ready	15mA	J.	off	blocking	blocking	discharged

Hold-up time

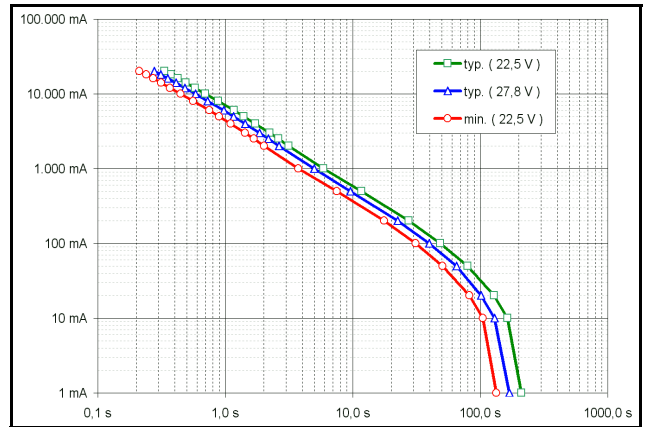

Buffer charging time

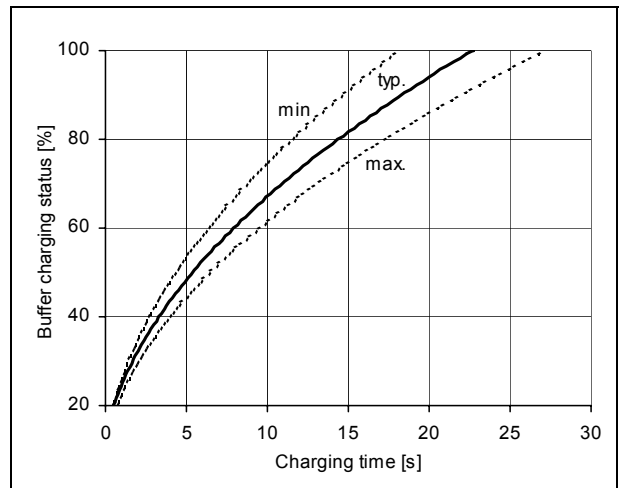

Operating modes

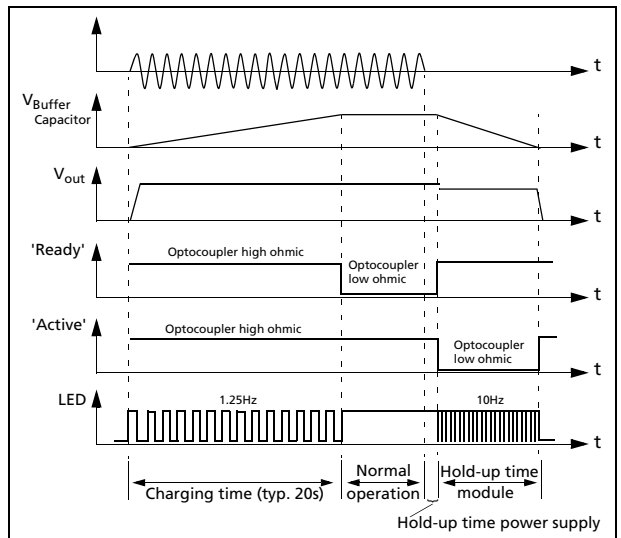

Connections

Terminals	Fingertouch-proof terminals with captive screws for 5.5mm slotted screwdriver or Philips cross-recessed screwdriver No. 2	
Positioning	Easy to reach terminals on the front panel. Signal connectors and powers terminals are clearly separate from each other.	
Tightening torque	0.7Nm recommended	
Connector size range		
• solid	0.5 ... 6mm ²	20AWG ... 10AWG
• flexible	0.5 ... 4mm ²	20AWG ... 12AWG
Ferrules	admissible	
Stripping length	7mm	

Front Elements, Operating Indicators and Elements

⊕	Positive power in/out (twice)
⊖	Negative power in/out (twice)
Chassis Ground \llcorner	Possibility to connect housing to ground
'Back-up Threshold'	
• Jumper pos. 2-3 (or missing)	Backup voltage: DC 22.5V fixed
• Jumper pos. 1-2	Backup voltage, variable: $V_{in} -1V$; backup activation on drop faster than typ. 0.54V/s and >1V
LED 'Status'	
• Off	Buffers are discharged, no external voltage or external voltage <22.5V
• Flashes (1.25Hz)	Buffer capacitors are charging
• On	Unit ready for operation, buffer is fully charged
• Flashes (10Hz)	Unit is buffering

Operating indicators and elements

Electromagnetic Compatibility(EMC)

Emissions	EN 61000-6-3 (also includes EN 61000-6-4) radiated noise and interference voltage on DC lines
Immunity	EN 61000-6-2 (also includes EN 61000-6-1)
• Electrostatic Discharge (ESD)	EN 61000-4-2, Level 4 (withstands 8kV direct discharge, 15kV air discharge; DIN rail earthed)
• Electromagnetic radiated fields	EN 61000-4-3, Level 3 (10V/m) ENV 50204 (10V/m)
• Burst, coupled to: - DCout lines	EN 61000-4-4, Level 3 (2 kV)
• Surge transients - Differential mode (+ → housing, - → housing)	EN 61000-4-5 500V
- Common mode (+ → -)	500V
• Conducted noise immunity	EN 61000-4-6, Level 3 (10V, 150kHz - 80MHz)

Approvals and Declarations of Conformity

The unit complies with all major **safety approvals**: EU (EN 60950), USA (UL 60950 recognized, UL 508 LISTED), CBScheme (IEC 60950), Canada (CAN/CSA-C22.2 No. 60950 [cUR], CAN/CSA-C22.2 No. 14 [cUL])

This unit has the following **declarations of conformity**: Europe (CE acc. to EMC and low voltage directive)

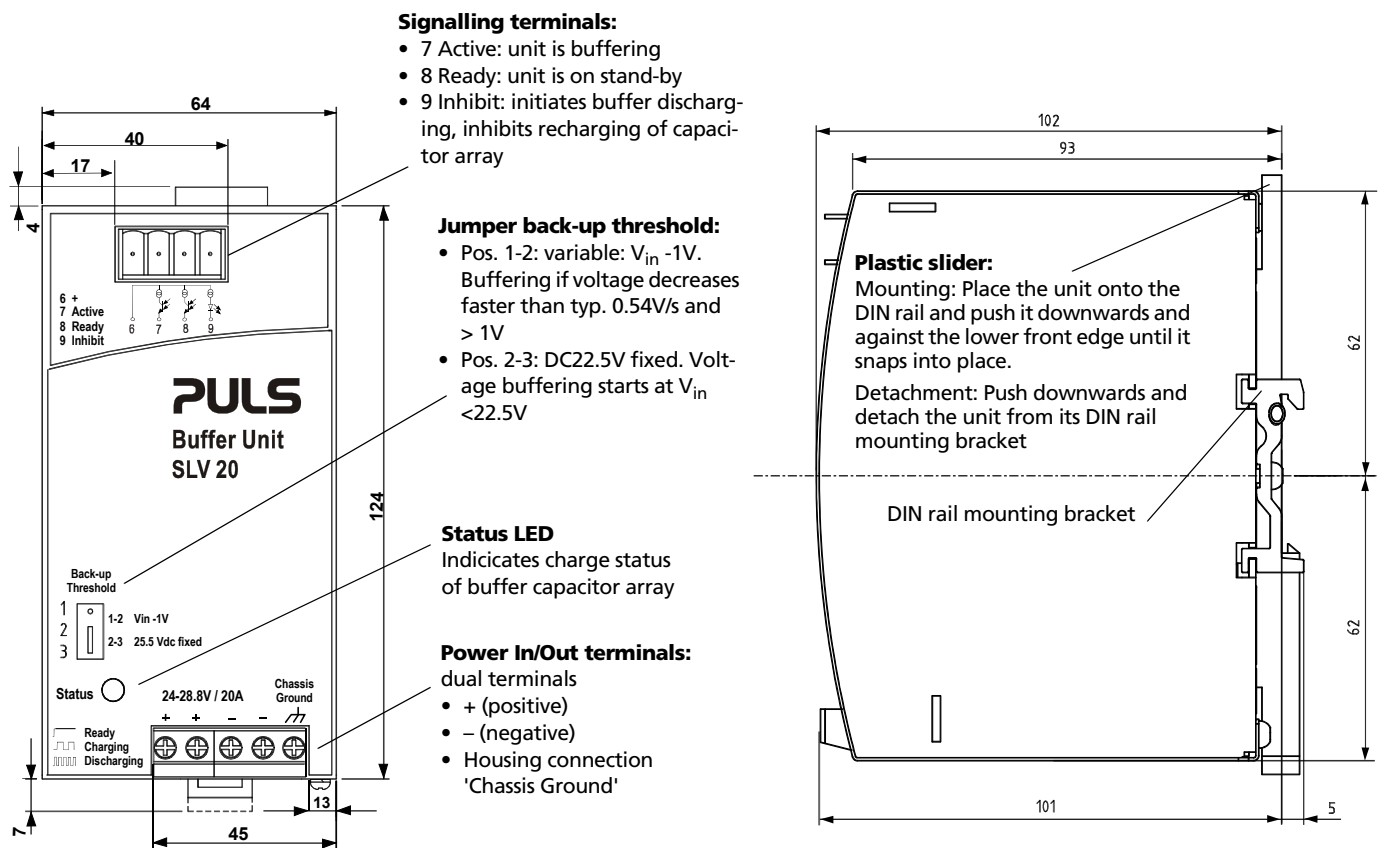

Schematic

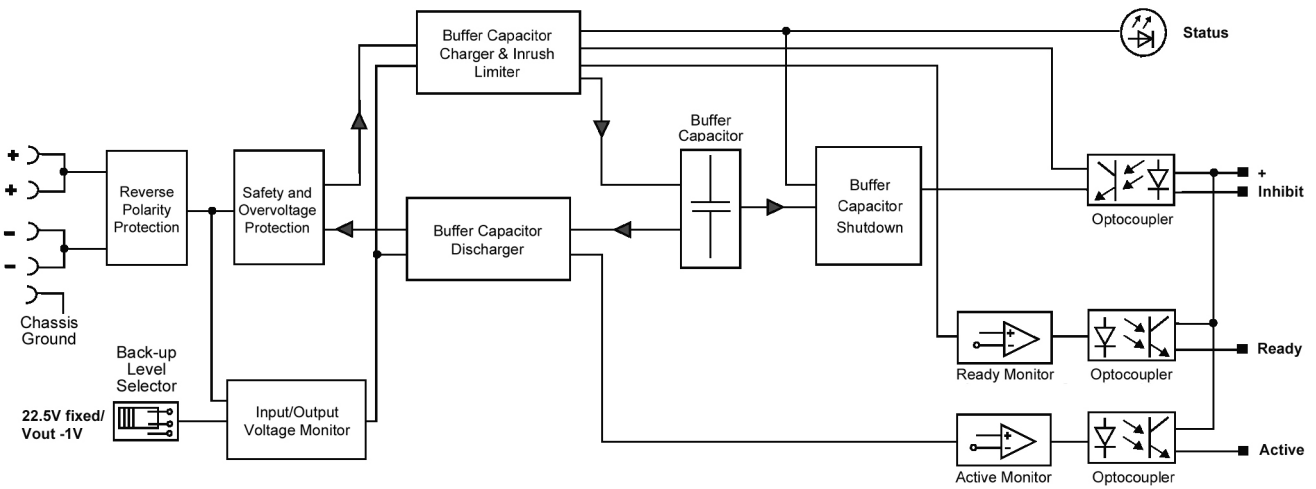

Signalling Terminals

Shared ⊕signal → signal (e.g. Inhibit)	DC 35V max.
Signal outputs	Optocoupler
• 7 – Active	low ohmic, while buffer capacitors are discharging
• 8 – Ready	low ohmic, when buffer is fully charged
Current	10mA max. permissible
Voltage drop across opto coupler	0.9V/1mA...3V/5mA (while low ohmic)
Leakage current	<100µA (while optocoupler blocks)
Signal input	Optocoupler
• 9 – Inhibit	'High' input signal initiates unit shutdown and buffer discharge
Shutdown threshold	>7...10V
Input current	<4mA
Isolation voltage	AC 500V against power path
Signal outputs and control input are protected against short-circuit, open circuit and overload.	

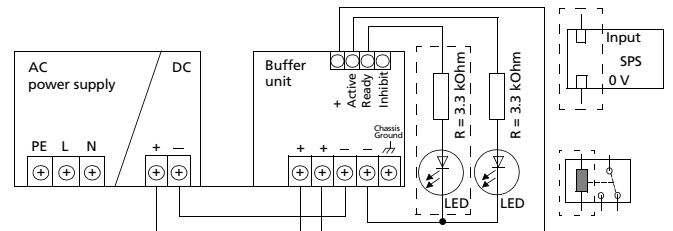

- Signalling output variants:
- LED + R = 3.3kOhm (see above)
 - Relay (R_L = 2kOhm)
 - SPS input

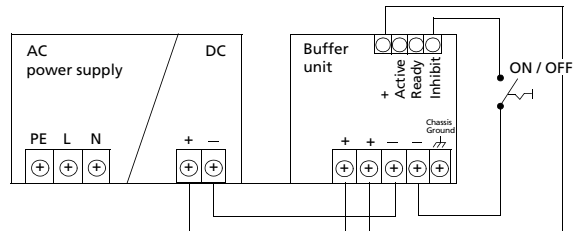

Installation Notes

Mounting position vertical; power in/out terminals below, signal terminal above

Admissible area of application: The buffer unit SLV20.200 has been designed for use in panel-board installations or other building-in applications where a suitable mechanical enclosure shall be provided to fulfill the requirements for shock-hazard protection and/or protection from hazardous energy levels as well as for fire protection.

Unless otherwise stated, specifications are valid for 'Ready' state, DC 24V input voltage and +25°C ambient temperature. They are subject to change without prior notice.

Your partner in power supply:



Bayerns Best 50
Czech 100 Best
Europe's 500

PULS GmbH
 Arabellastraße 15
 D-81925 München
 Tel.: +49 89 9278-0
 Fax: +49 89 9278-299
 www.puls-power.com